

FARAD[®] BARS

made in italy

Evolution Srl unipersonale, Via A. De Gasperi 26, 12040 Sanfrè (CN) Italy

www.faradworld.com

+39 0172 58575

BS 198

FIAT TIPO SW 2016 >

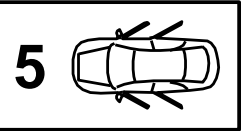

I Istruzioni di montaggio

F Instructions de montage

PL Instrukcja montażu

D
E Einbauanleitung

GB Fitting instructions

Instrucciones de montaje

NL Inbouwhandleiding

SWE Montageanvisnin

KIT BS

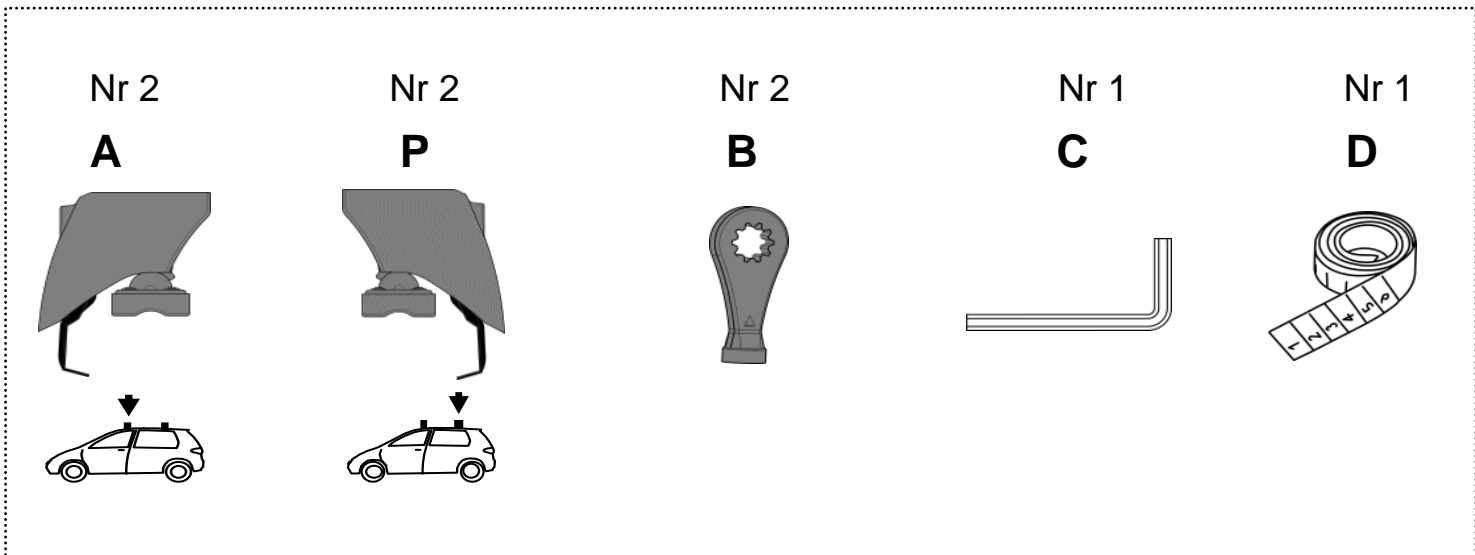

KIT ALU

+

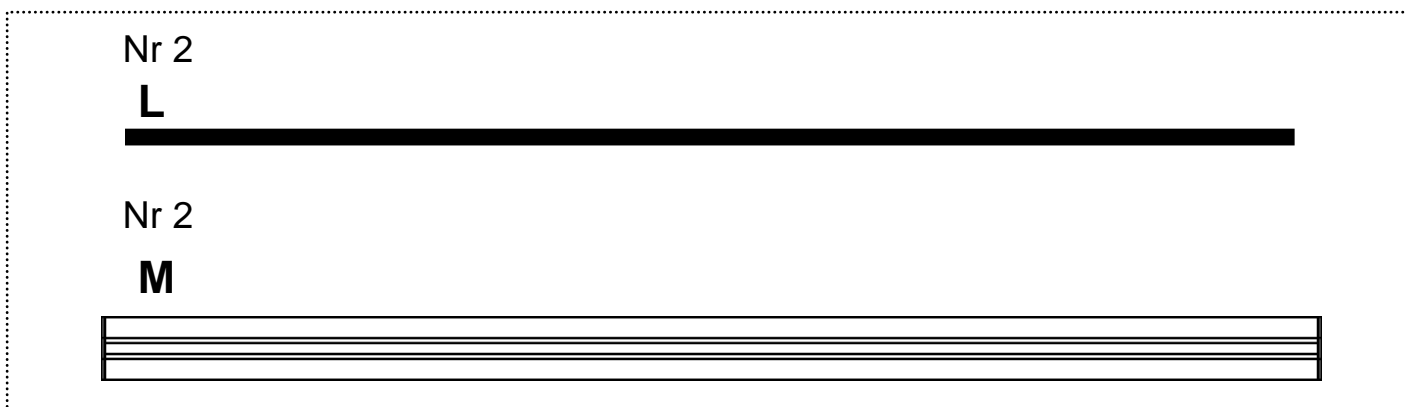

=

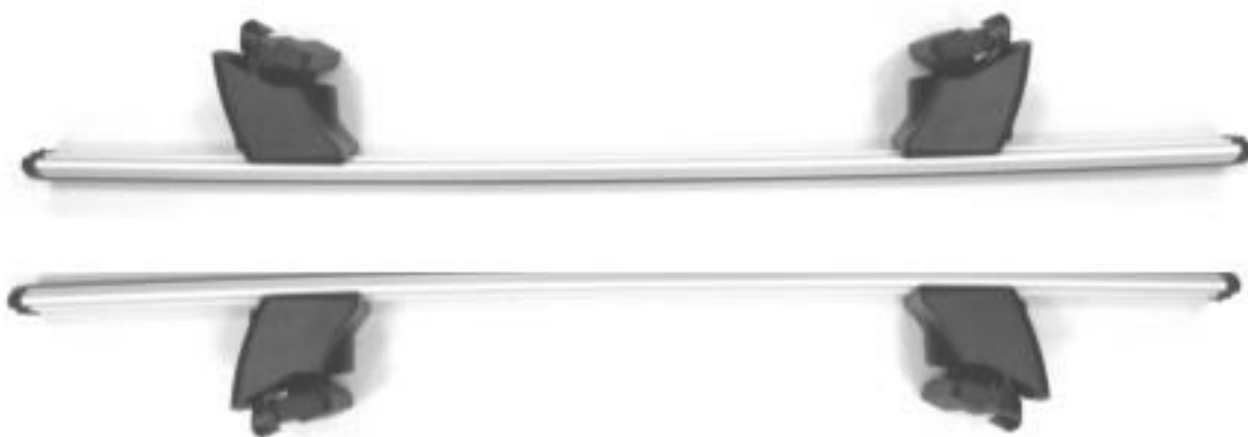

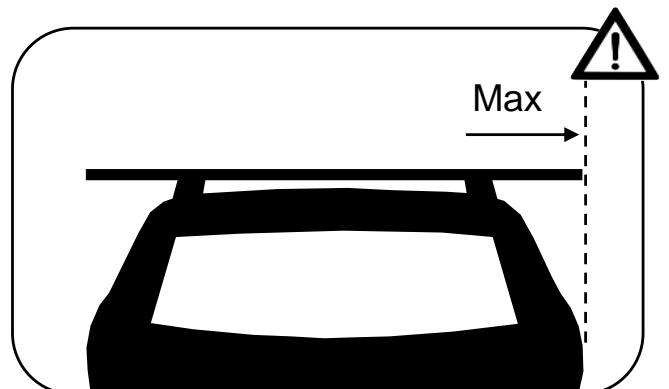
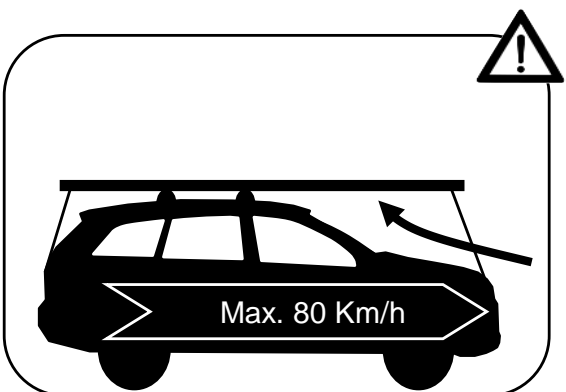
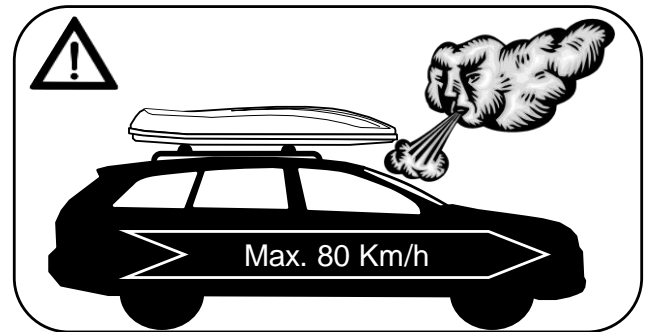
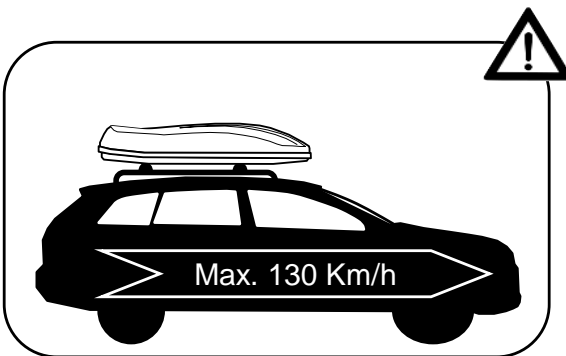
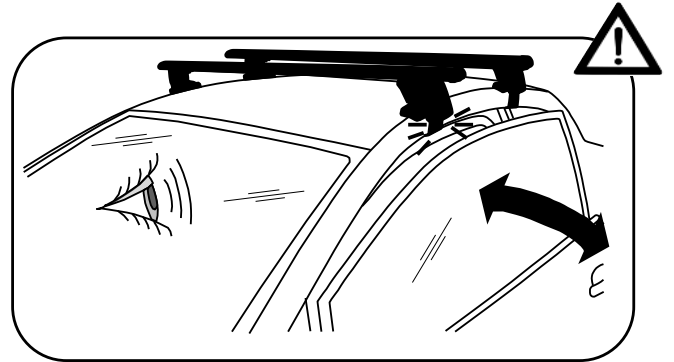
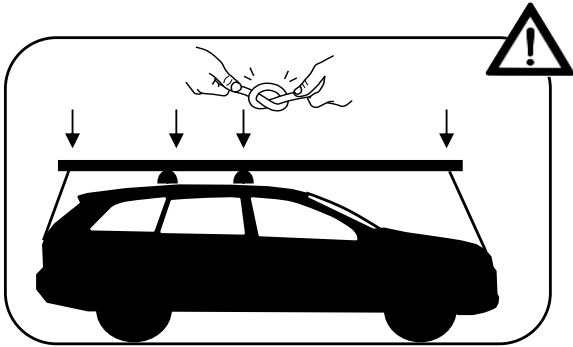
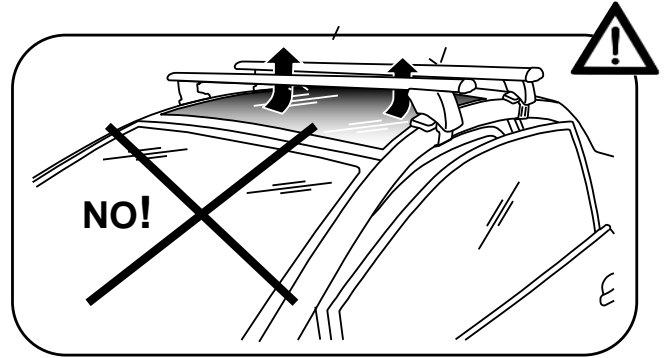
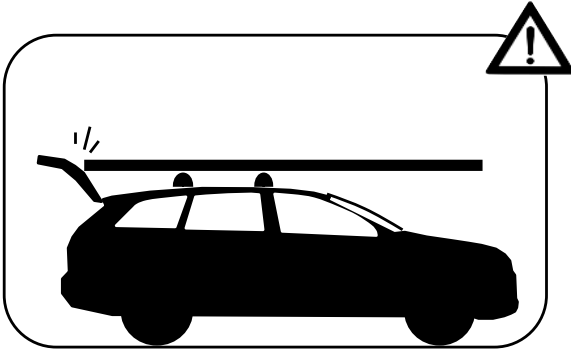
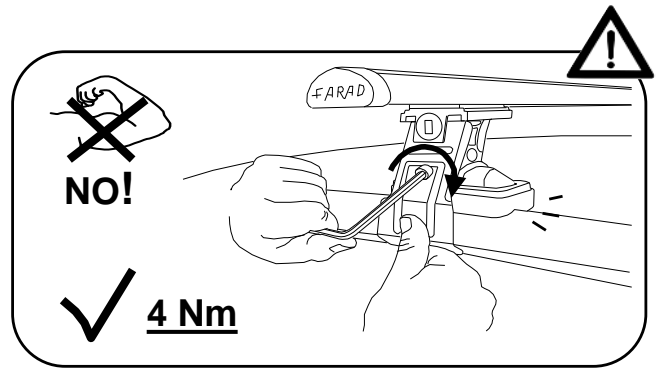
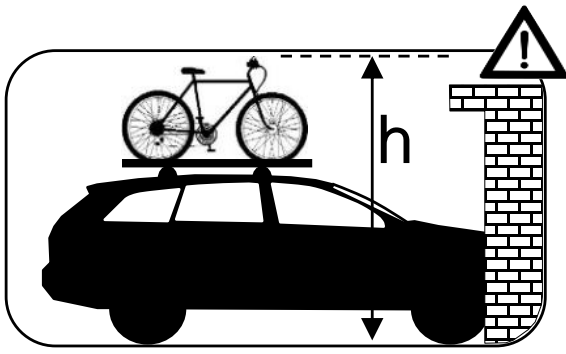

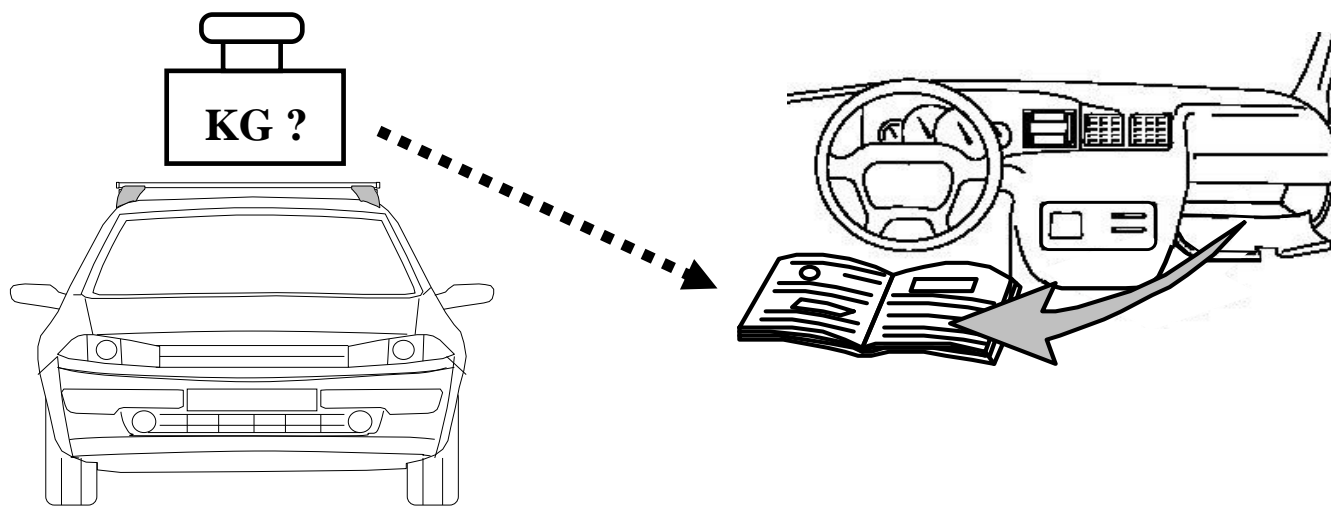

- I Controllare carico del tetto sul manuale dell'auto
- PL Sprawdz ładownoœć dachu w instrukcji
- GB Check roof load capacity in car instruction
- NL check de handleiding belasting van het dak van de auto
- F vérifier le chargement manuel du toit de la voiture
- D überprüfen Sie die manuelle Beladung der Autodach
- E comprobar la carga manual del techo del coche
- SWE kontrollera manuell inläggning på taket av bilen

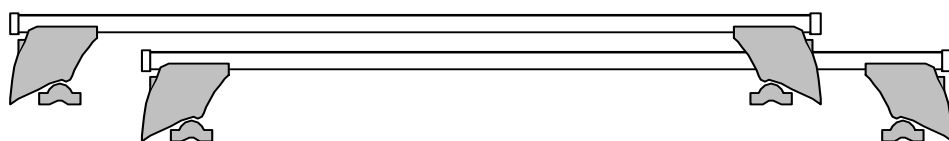
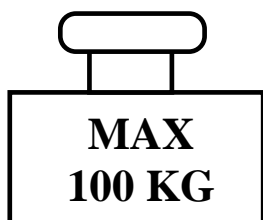
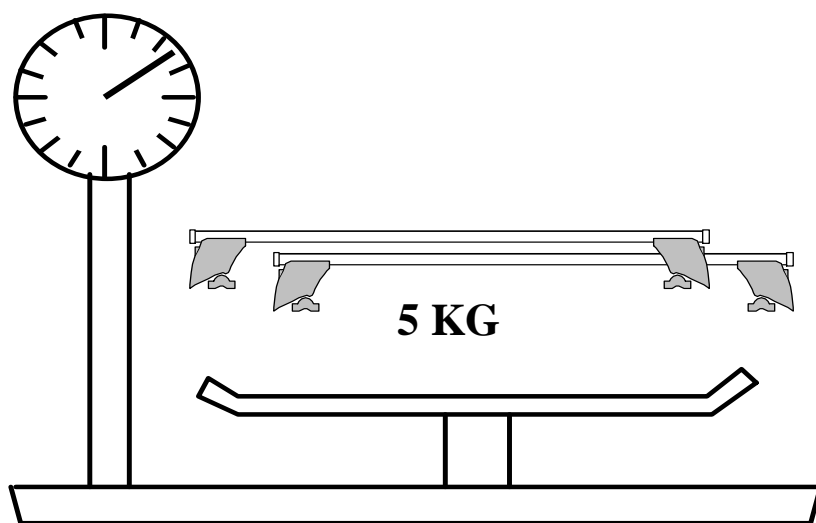

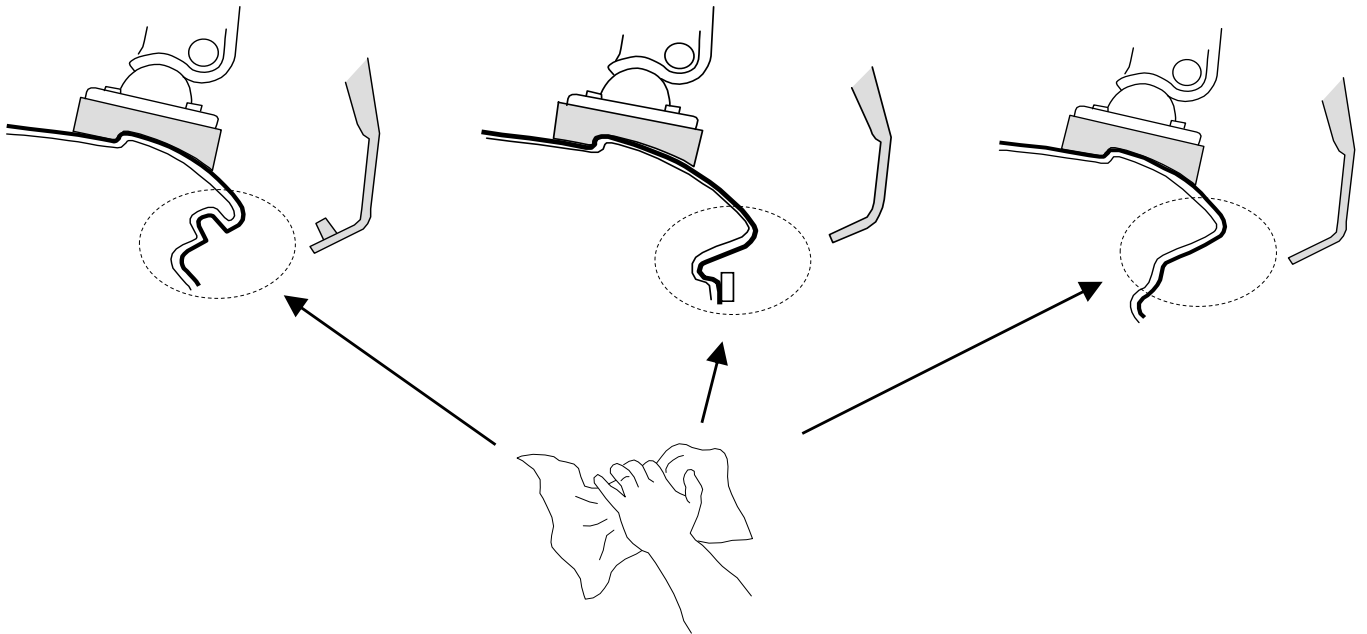
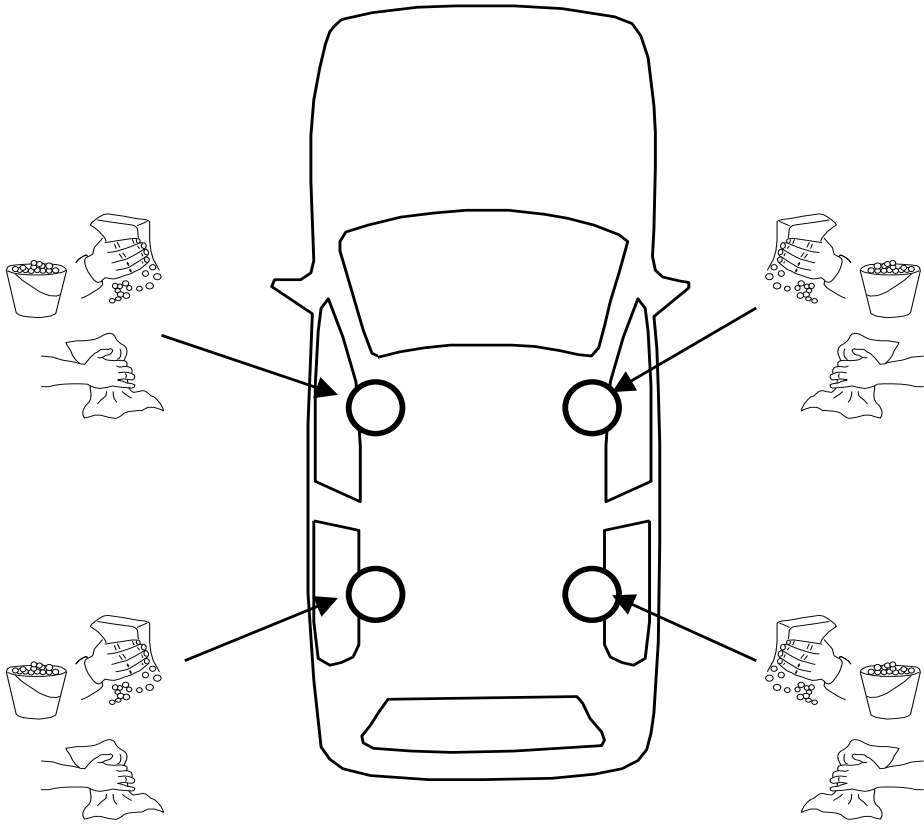

I **Montaggio Barra Anteriore**

F **Fixation Barre Avant**

PL **Montaż Bagażnika Bazowego Tylnego**

GB **Fitting Front Roof Bar**

D **Montage Vorderes Dachträgers**

NL **Montage Voorste Dakdrager**

SWE **Montering Av Främre Lasthållaren**

E **Fijación Barra Frontal**

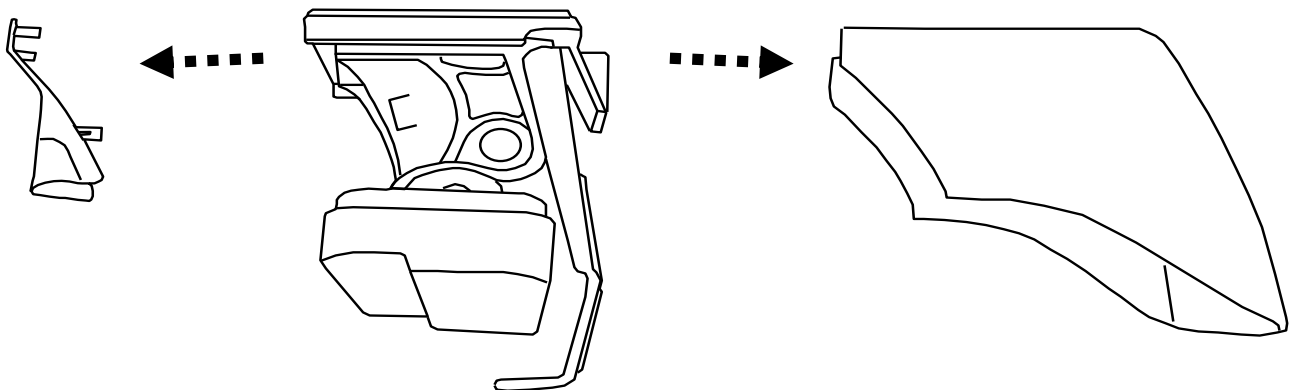
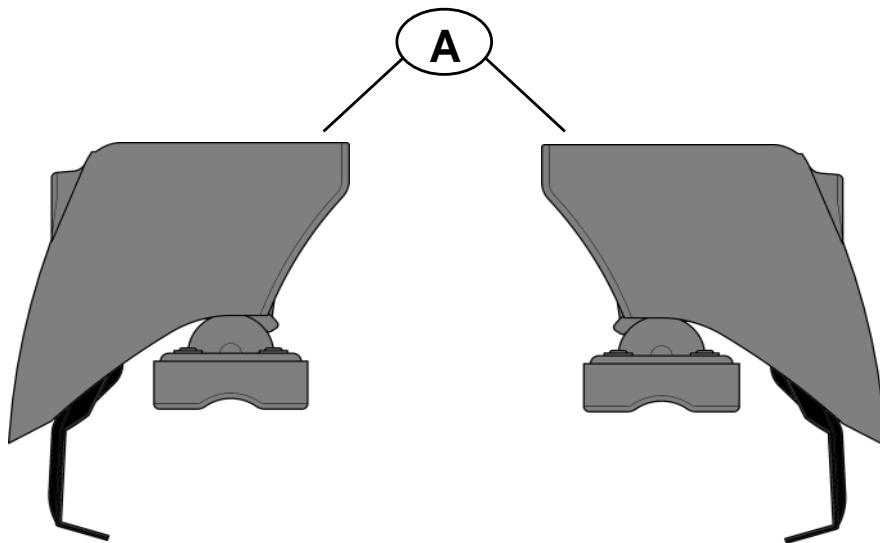
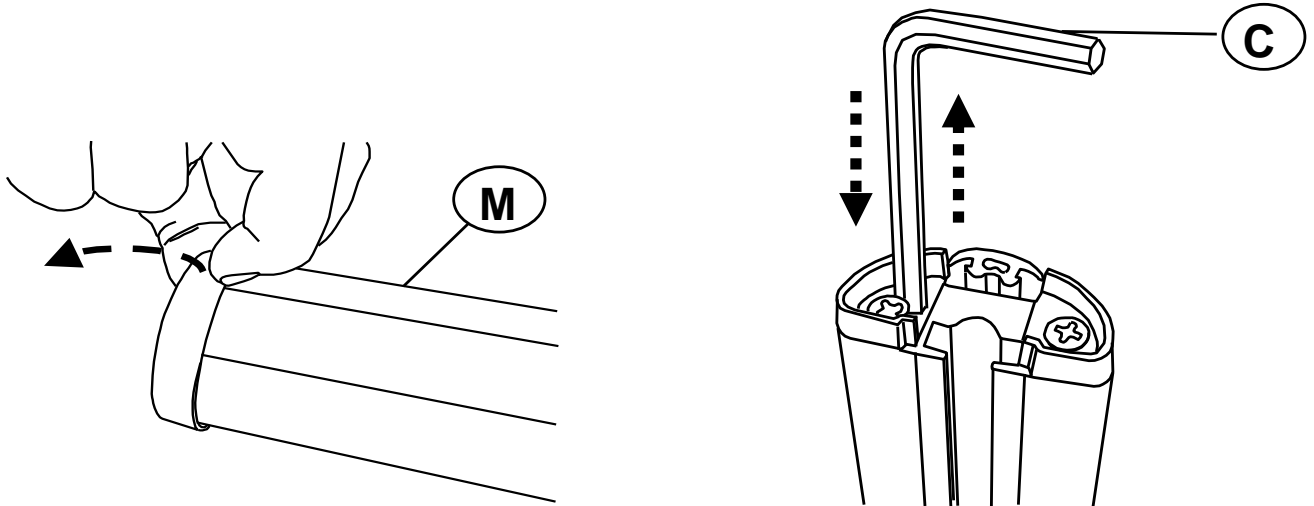

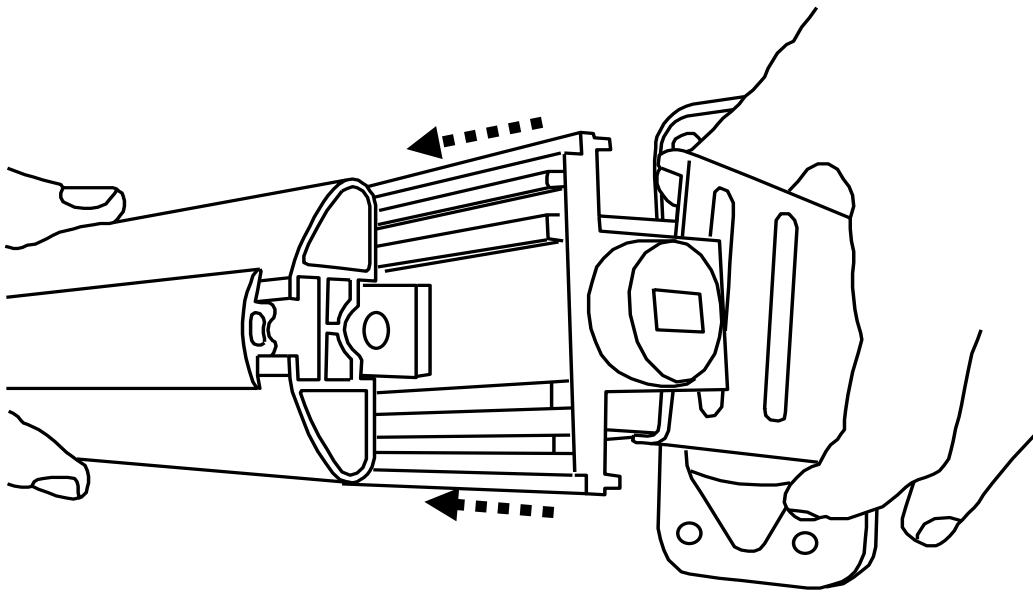
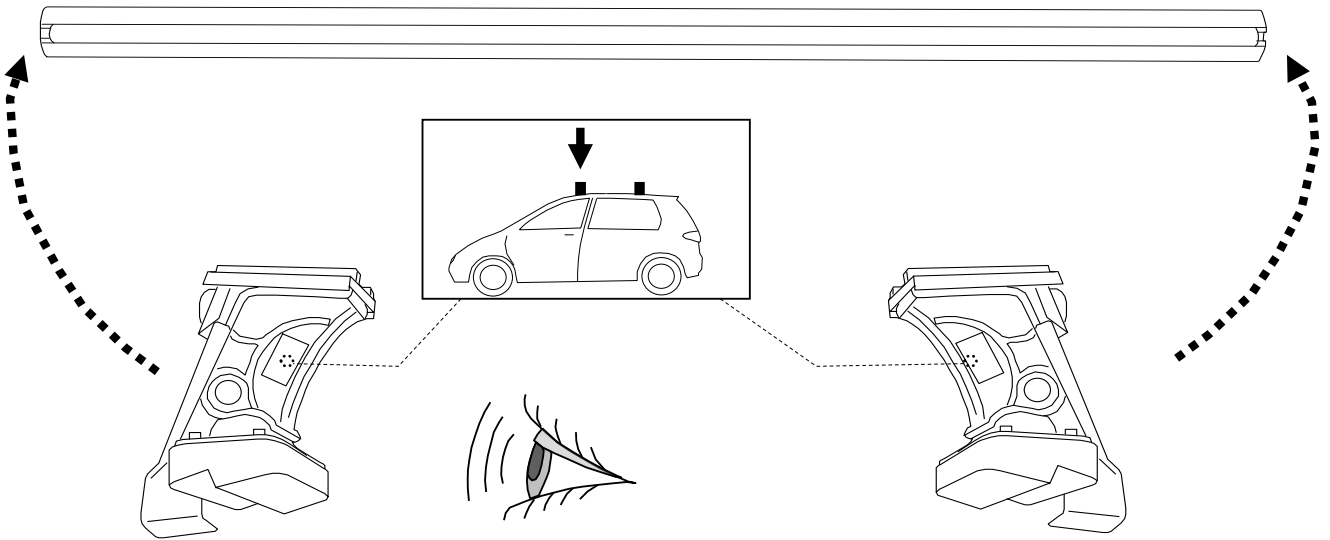

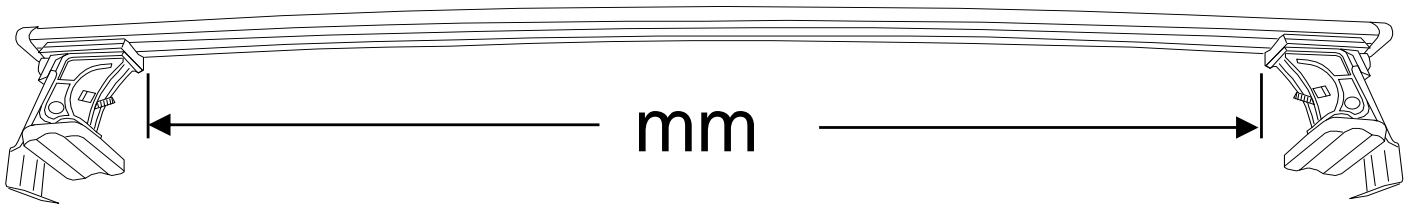

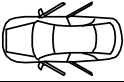
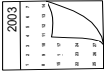
			R	mm
FIAT	TIPO SW	5	R= 27	1000

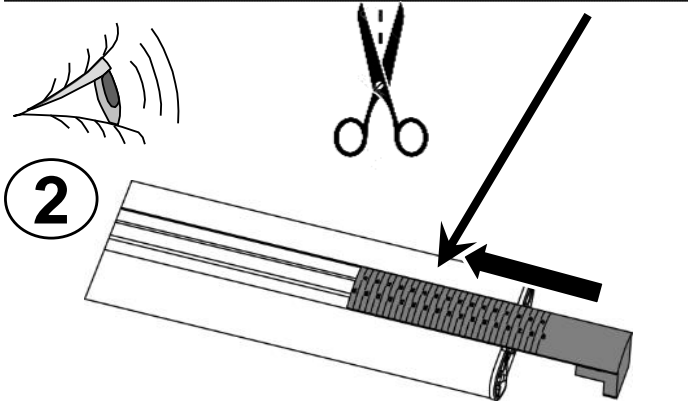
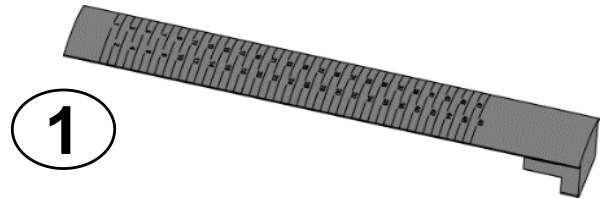
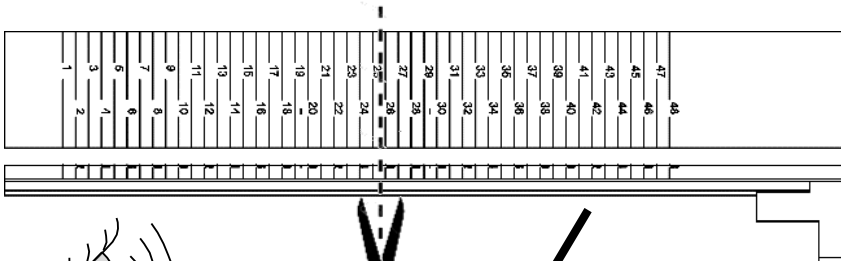

3

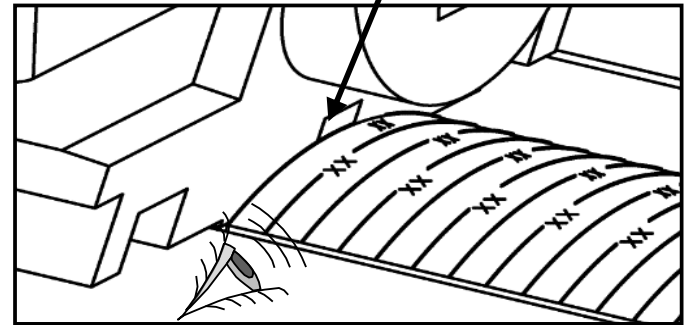
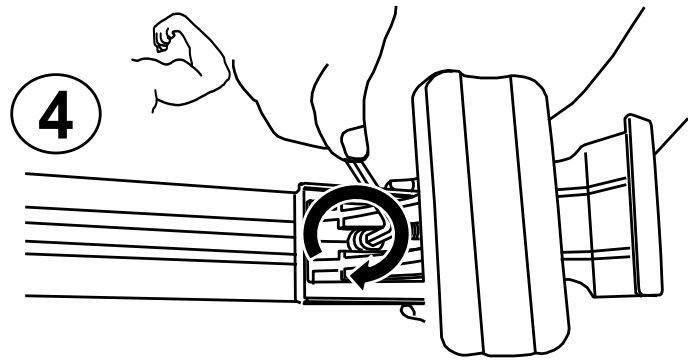
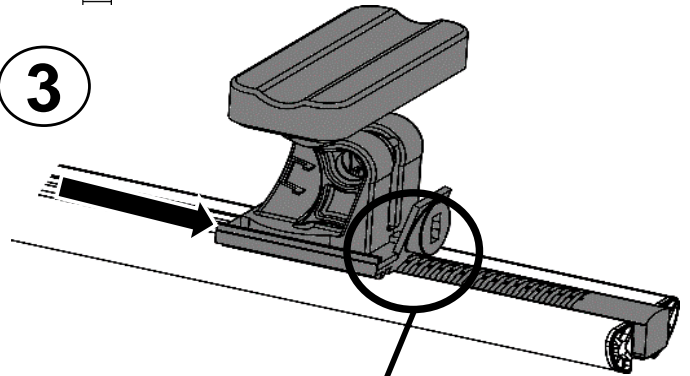



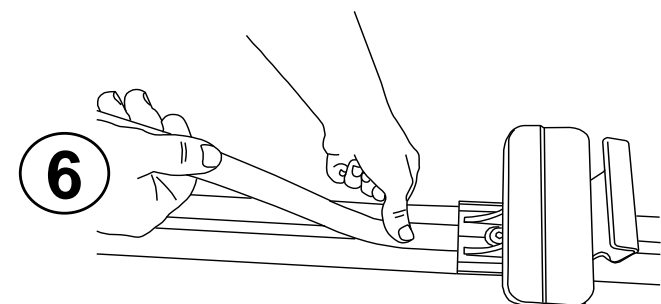
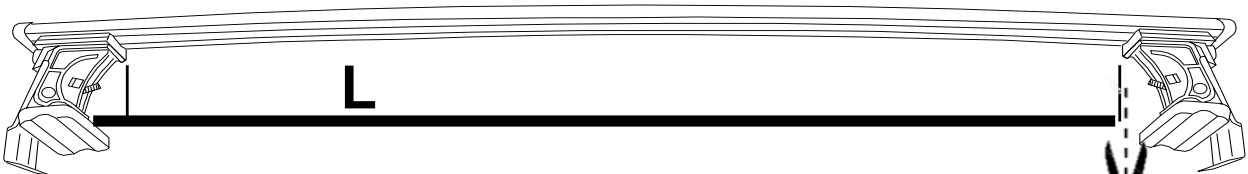

5

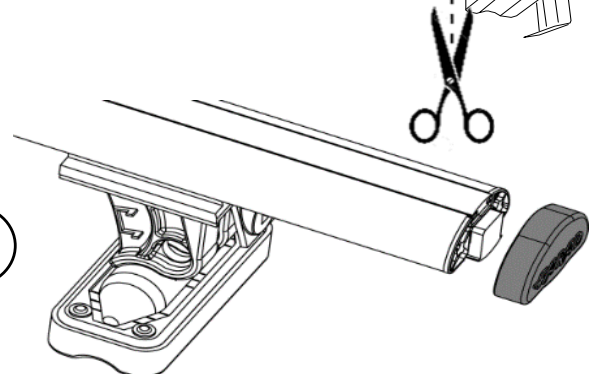

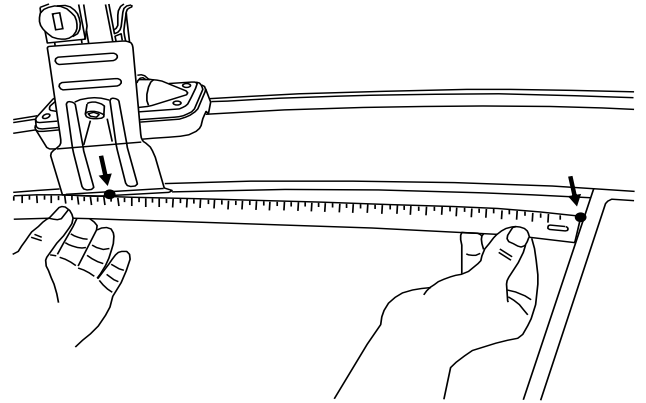
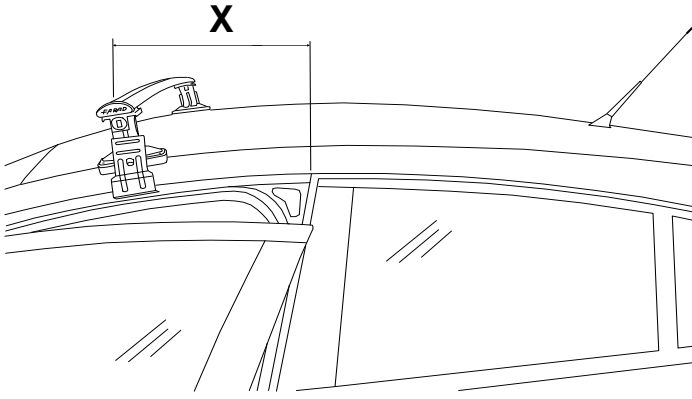
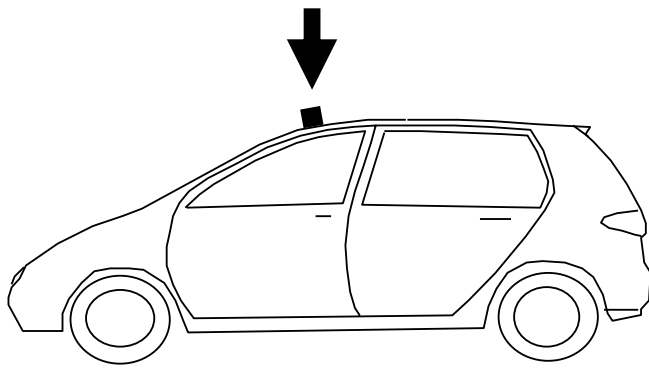
7



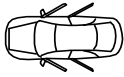

			X
FIAT	TIPO SW	2016 >	X= 170

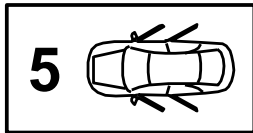

✓ **4 Nm**

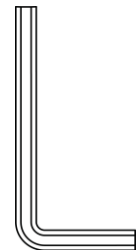
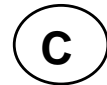
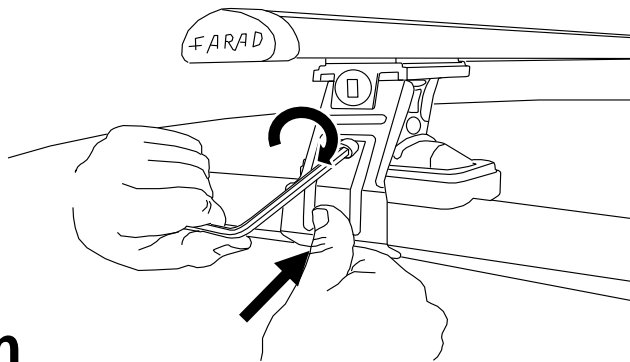

REV 000	16/02/2023	9 / 20
----------------	-------------------	---------------

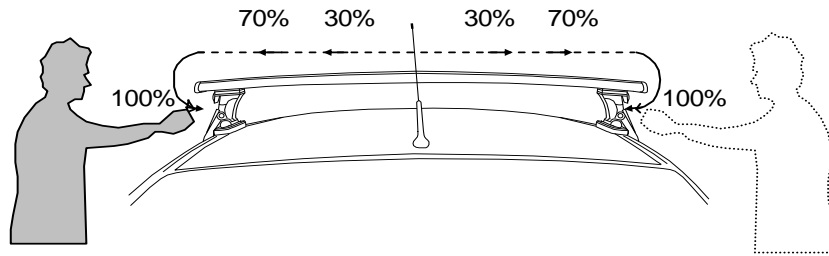

- | | | | |
|----|---|-----|------------------------------------|
| I | Alternare il fissaggio delle viti | F | Serrer alternativement chaque côté |
| PL | Śruby dokręcaj naprzemiennie | D | Die Schrauben abwechselnd anziehen |
| GB | Tighten alternately | E | Apretar alternativamente |
| NL | Afwisselend aan de linker- en de rechterkant aandraaien | SWE | Dra åt växelvis |

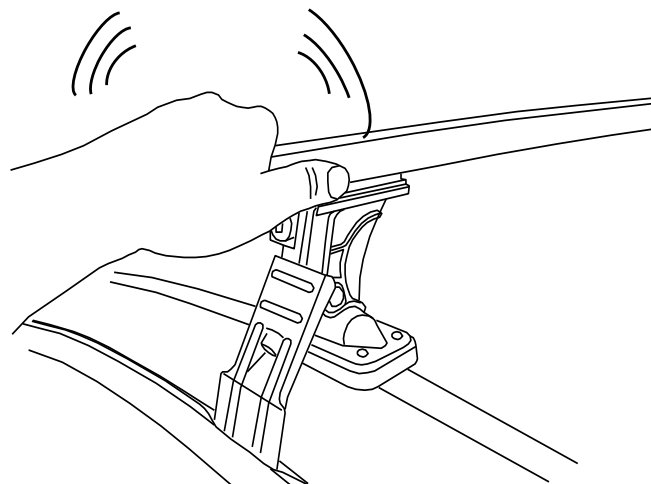
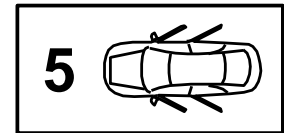
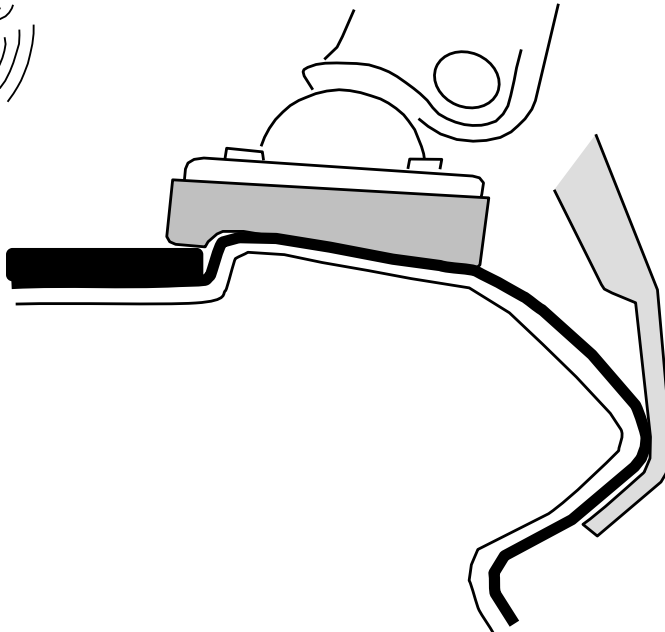

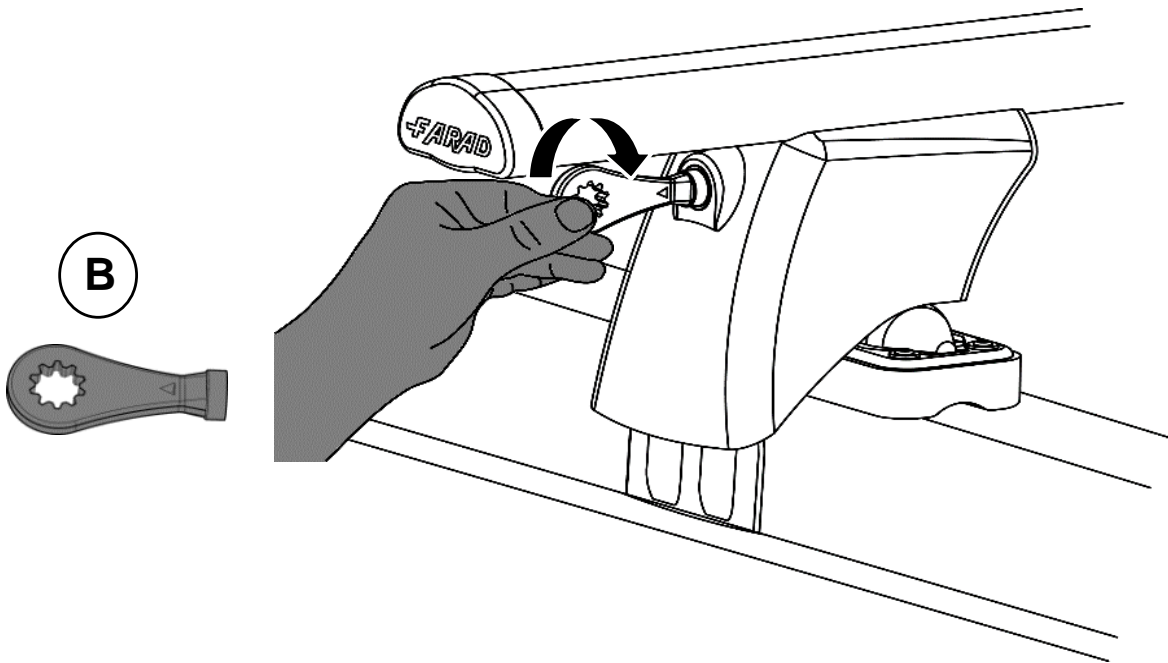
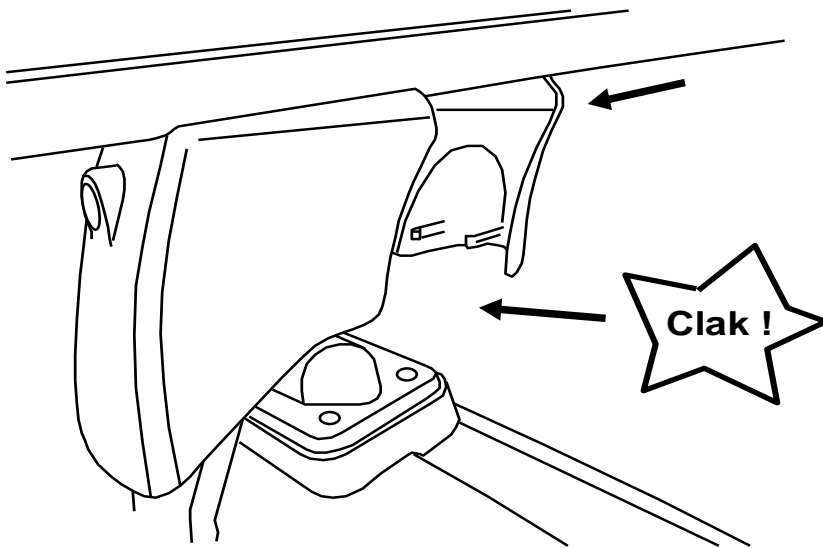
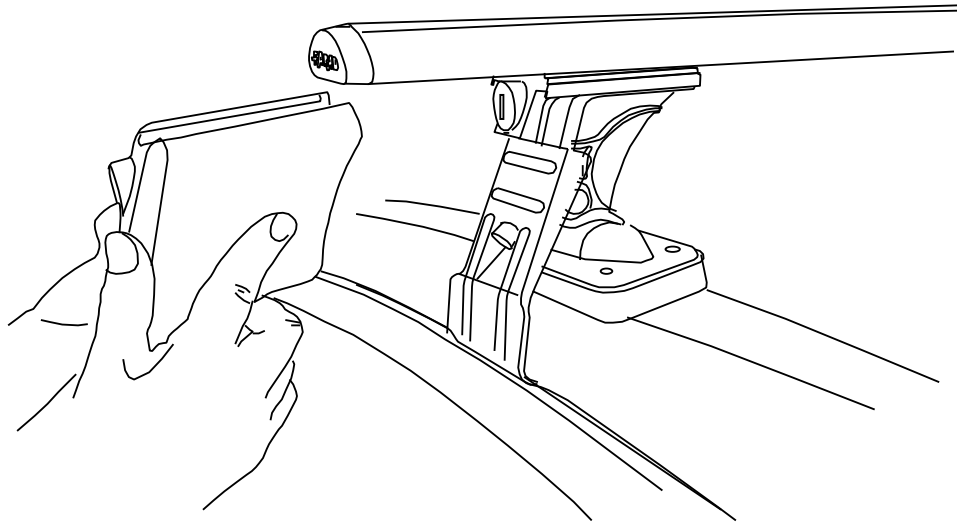

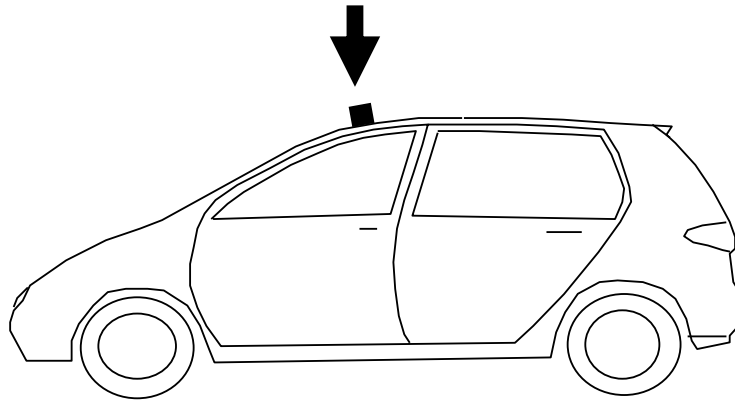
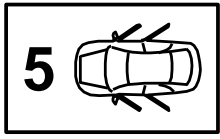

- I** CONTROLLARE PERIODICAMENTE IL FISSAGGIO DELLE VITI
- PL** OKRESOWO SPRAWDZAJ MOCOWANIE ŚRUB
- GB** CHECK THE SCREW FASTENING PERIODICALLY
- D** REGELMÄSSIG ÜBERPRÜFEN DIE BEFESTIGUNG DER SCHRAUBEN
- SWE** REGELBUNDET KONTROLLERA OM FASTSTÄLLANDE AV SKRUVARNA
- F** VERIFIEZ LA FIXATION DES VIS PERIODIQUEMENT

I Montaggio barra posteriore

F Fixation Barre Arriere

PL Montaż Bagażnika Bazowego Przedniego

GB Fitting Rear Roof Bar

Montering Främre Lasthållaren

E Fijación Barra Trasera

NL Montage Achterste Dakdrager

D Montage Heckdachträgers

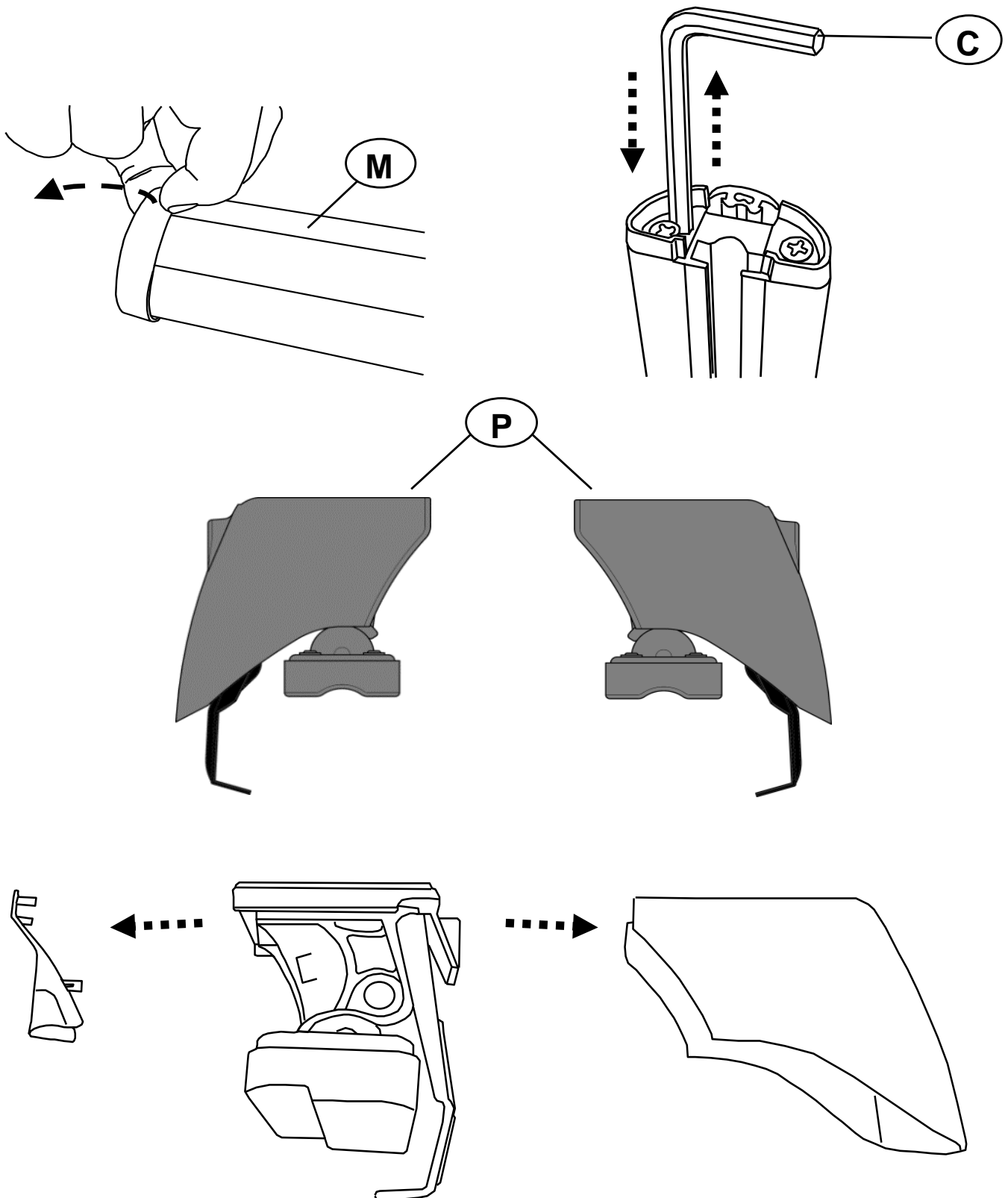

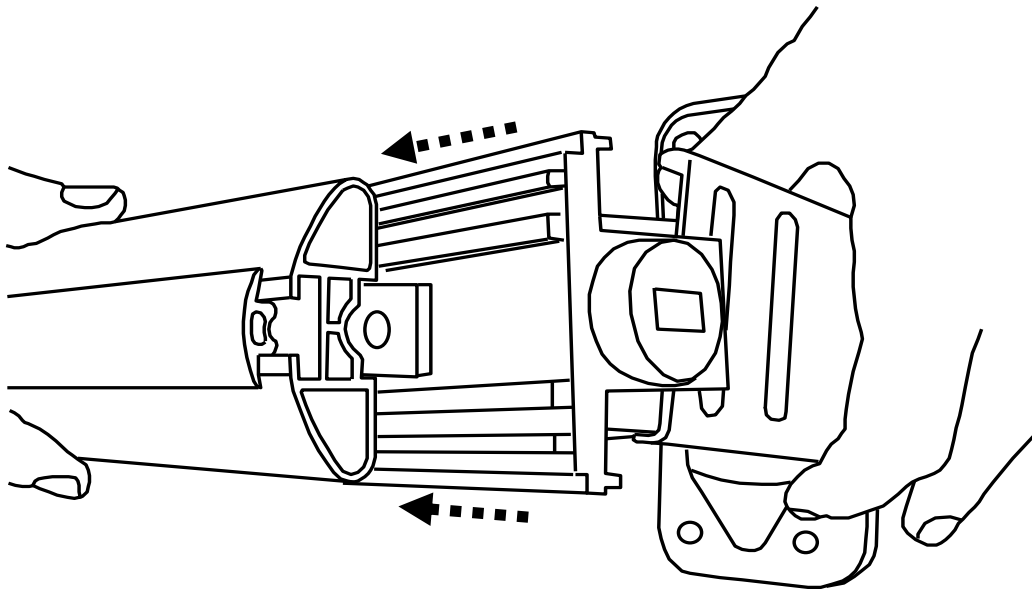
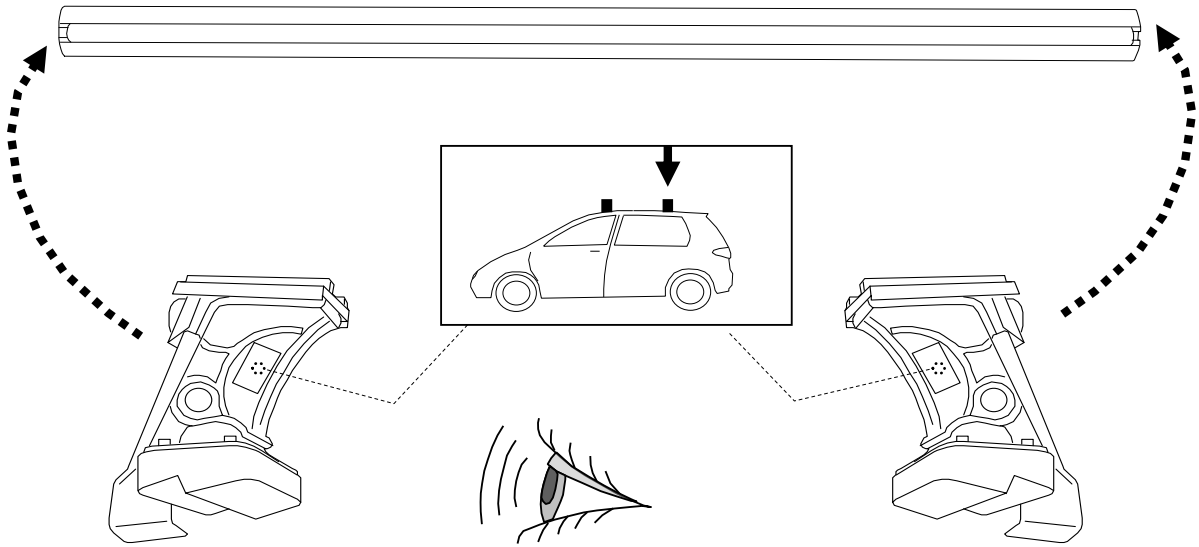

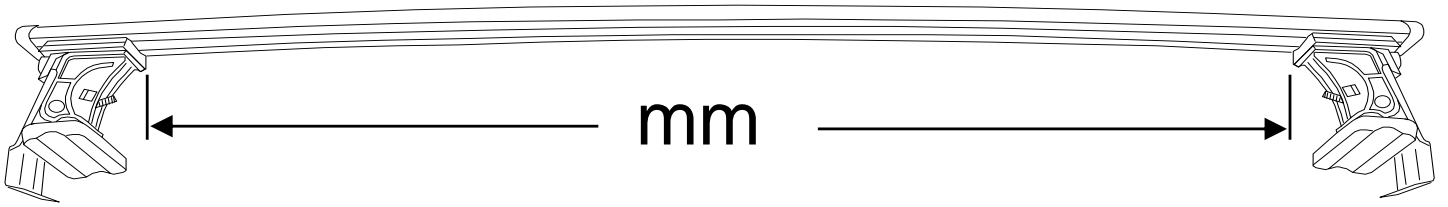

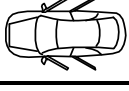
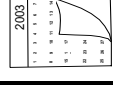

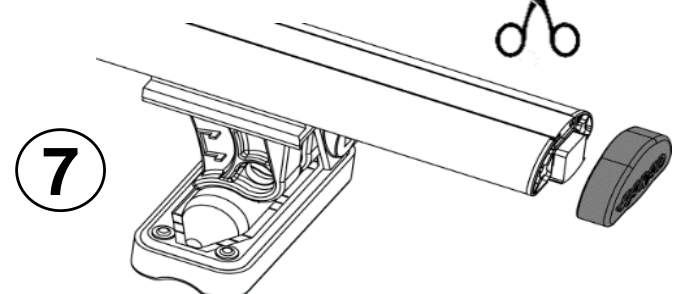
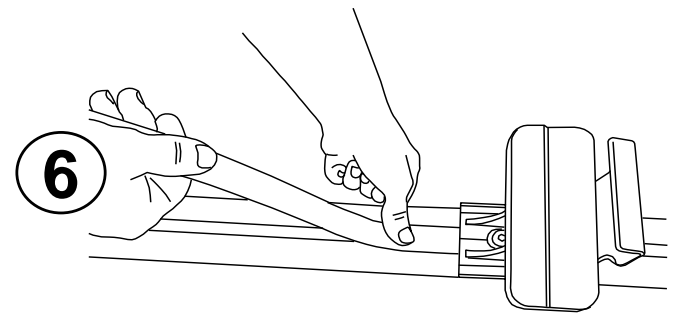
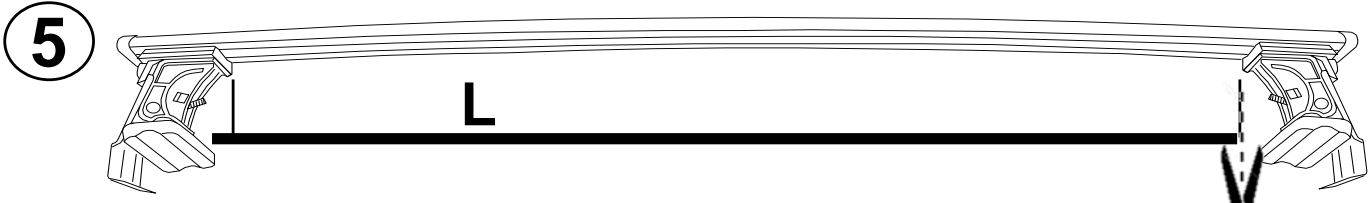
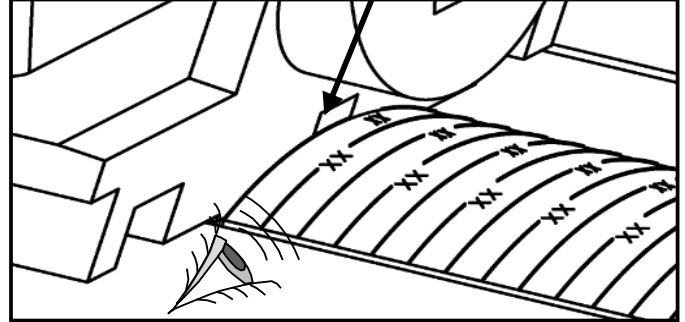
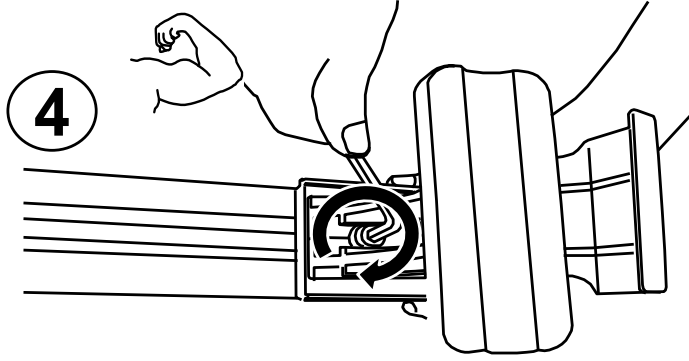
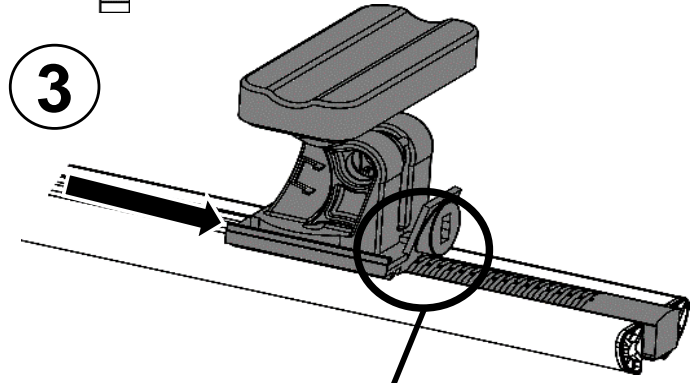
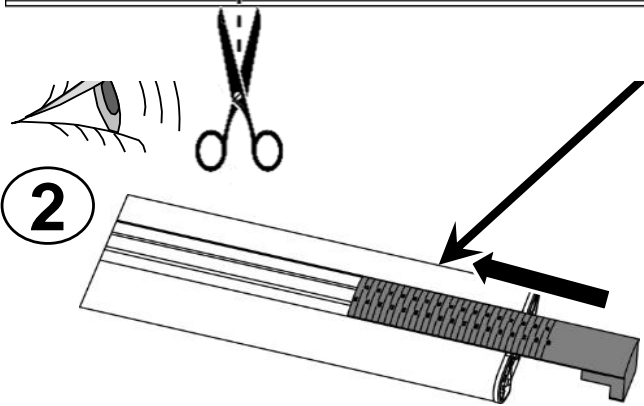
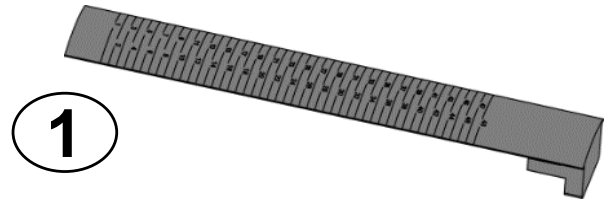
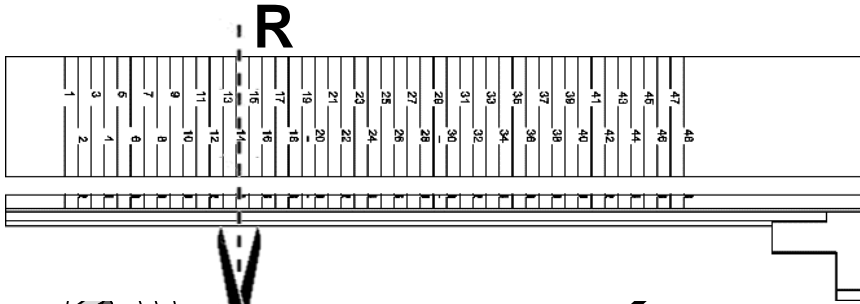
			R	mm
FIAT	TIPO SW	5	R= 15	940

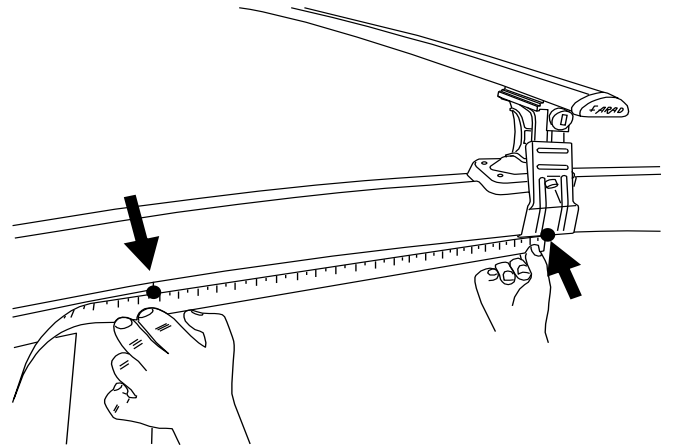
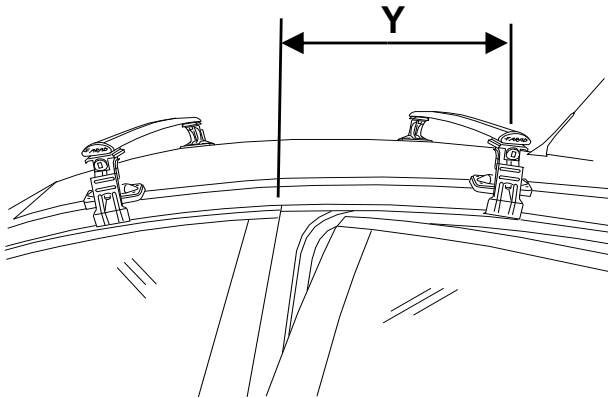
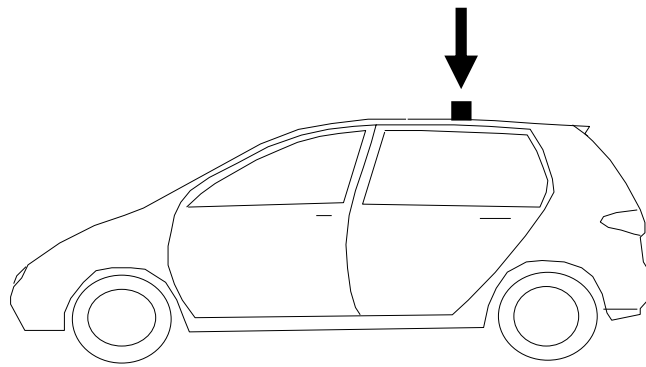

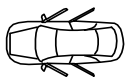
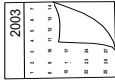

			Y
FIAT	TIPO SW	2016 >	Y= 600



✓ **4 Nm**

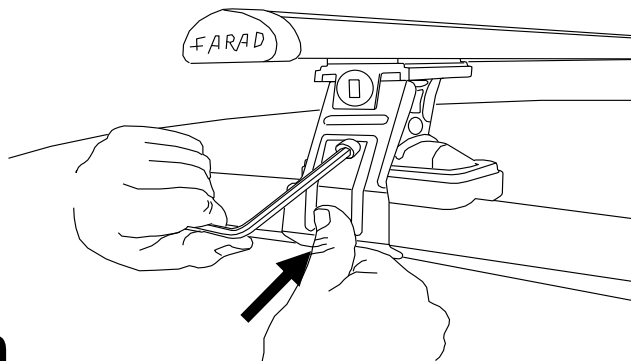

C

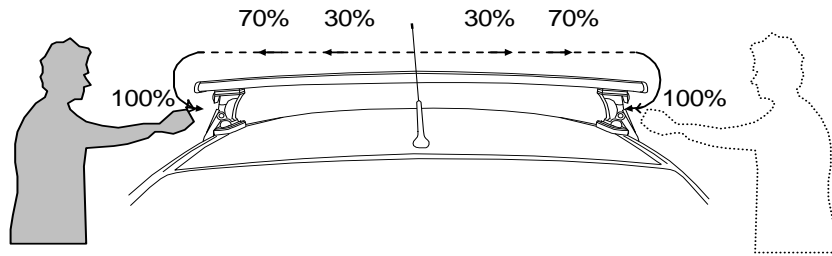

- | | | | |
|----|---|-----|------------------------------------|
| I | Alternare il fissaggio delle viti | F | Serrer alternativement chaque côté |
| PL | Śruby dokręcaj naprzemiennie | D | Die Schrauben abwechselnd anziehen |
| GB | Tighten alternately | E | Apretar alternativamente |
| NL | Afwisselend aan de linker- en de rechterkant aandraaien | SWE | Dra åt växelvis |

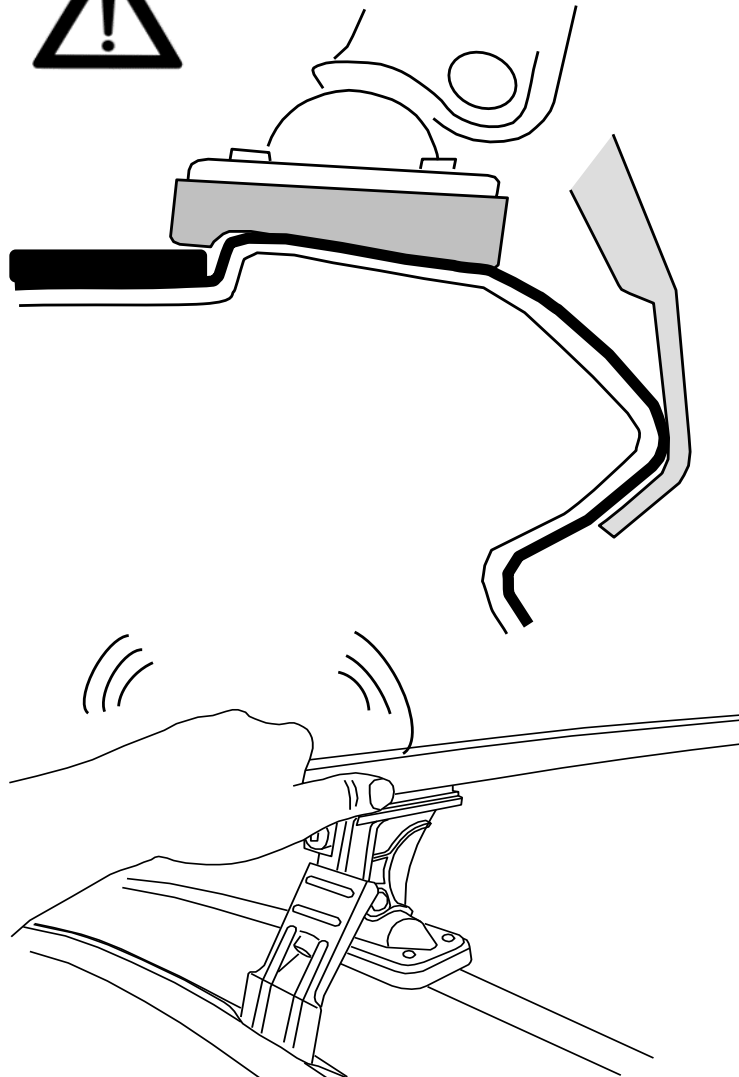
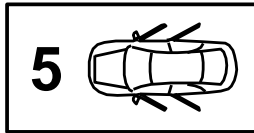

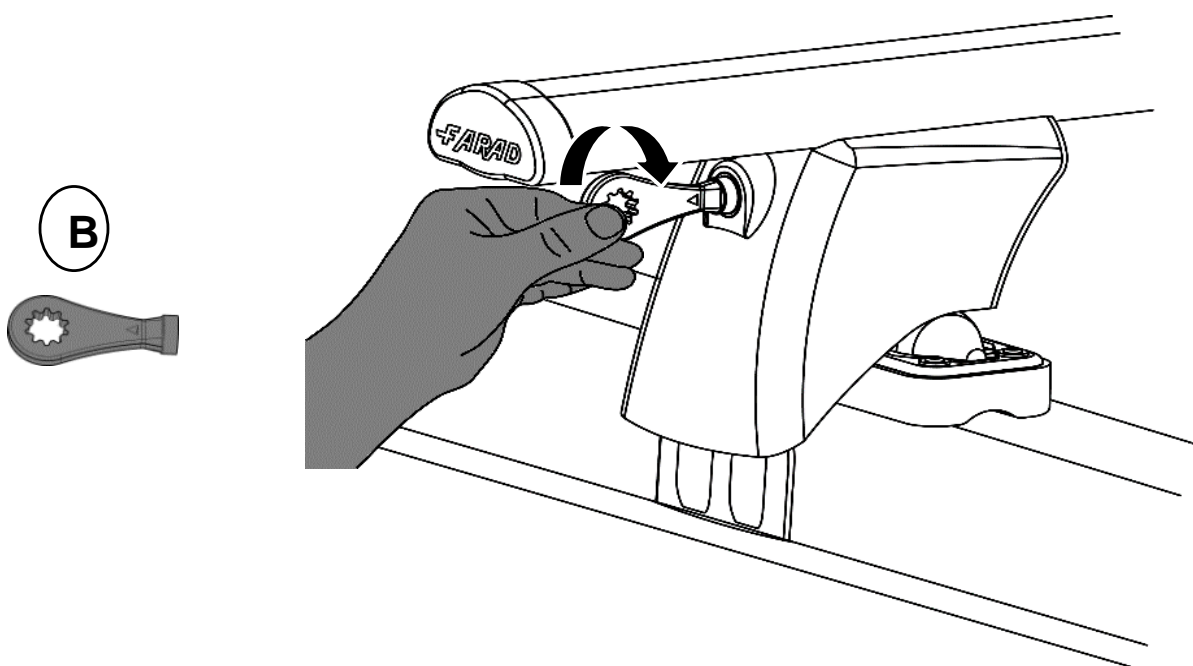
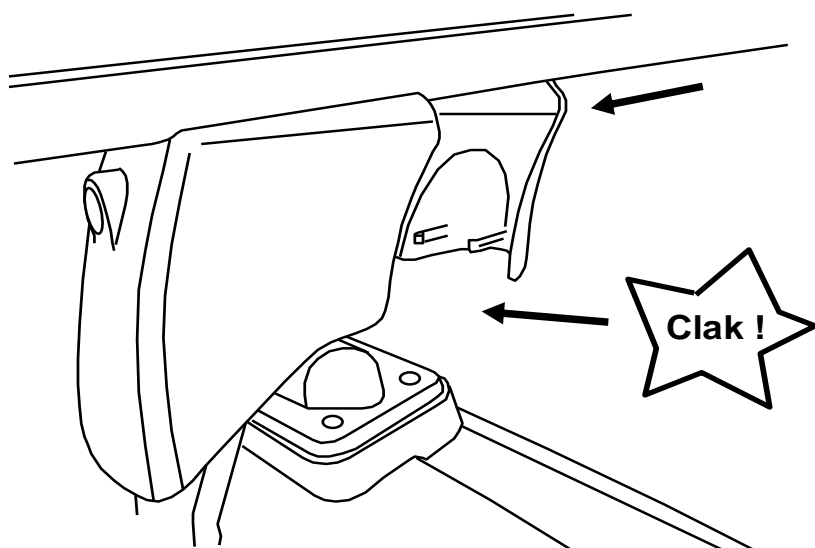
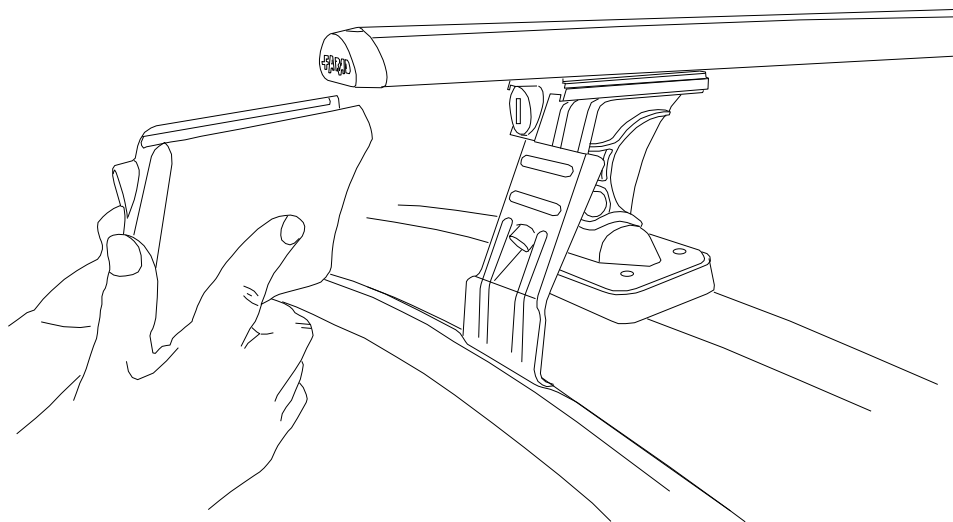

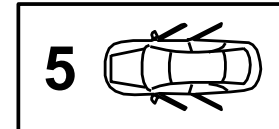
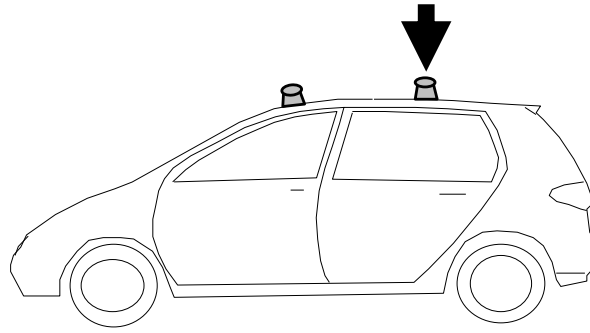

- I** CONTROLLARE PERIODICAMENTE IL FISSAGGIO DELLE VITI
- PL** OKRESOWO SPRAWDZAJ MOCOWANIE ŚRUB
- GB** CHECK THE SCREW FASTENING PERIODICALLY
- D** REGELMÄSSIG ÜBERPRÜFEN DIE BEFESTIGUNG DER SCHRAUBEN
- SWE** REGELBUNDET KONTROLLERA OM FASTSTÄLLANDE AV SKRUVARNA
- F** VERIFIEZ LA FIXATION DES VIS PERIODIQUEMENT

RICAMBI - SPARE PARTS



PIEDE GIREVOLE
90341 / 2

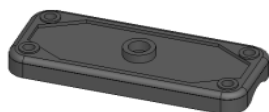

PIEDE FISSO
90341 / 15

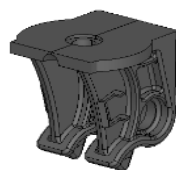

SUPPORTO CENTRALE
90341 / 1

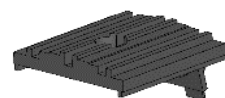

SUPPORTO BARRA
90341 / 5



SOTTO PIEDE SP01
90341 / 3



SOTTO PIEDE SP03
90341 / 16



SOTTO PIEDE SP04
90341 / 13

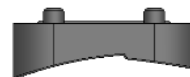

SOTTO PIEDE SP07
90341 / 11

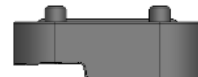

SOTTO PIEDE SP08
90341/14



SOTTO PIEDE SP10
90341 / 12



SOTTO PIEDE SP12
90341 / 1



CHIAVE ESAGONALE 6
9331 / 148

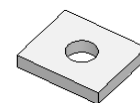

PIASTRINA



DISTANZIALE
90341 / 20



NOTTOLINO + N° COMB.
90341 / 6



SOTTOTAPPO
90241 / 9



TAPPO BARRA
90241 / 6

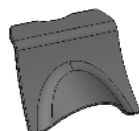

INVOLUCRO POST.
90341 / 9

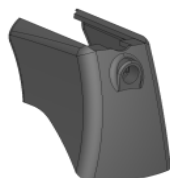

INVOLUCRO ANTERIORE
90341 / 8



CHIAVE + N° COMB
90341 / 7

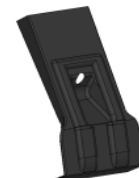

PALETTA
90341 / 4



BARRA ALLUMINIO
90241 / 7



GUARNIZIONE BARRA
90241 / 8



RIGA CARTA
90341 / 19

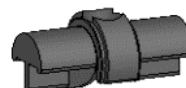

PERNO
90241 / 15



GUARNIZIONE
NUMERICA
91141 / 14

FARAD[®]
made in italy

www.faradworld.com

