

FARAD[®] BARS

made in italy

Evolution Srl unipersonale, Via A. De Gasperi 26, 12040 Sanfrè (CN) Italy

www.faradworld.com

+39 0172 58575

BS 035 - 1

HYUNDAI IX20 2010-2019

KIA VENGA 2010-2019

TOYOTA AURIS 2007-2012

TOYOTA AURIS 2013-2018

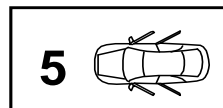

I Istruzioni di montaggio

F Instructions de montage

PL Instrukcja montażu

D Einbauanleitung

GB Fitting instructions

E Instrucciones de montaje

NL Inbouwhandleiding

SWE Montageanvisnin

KIT BS

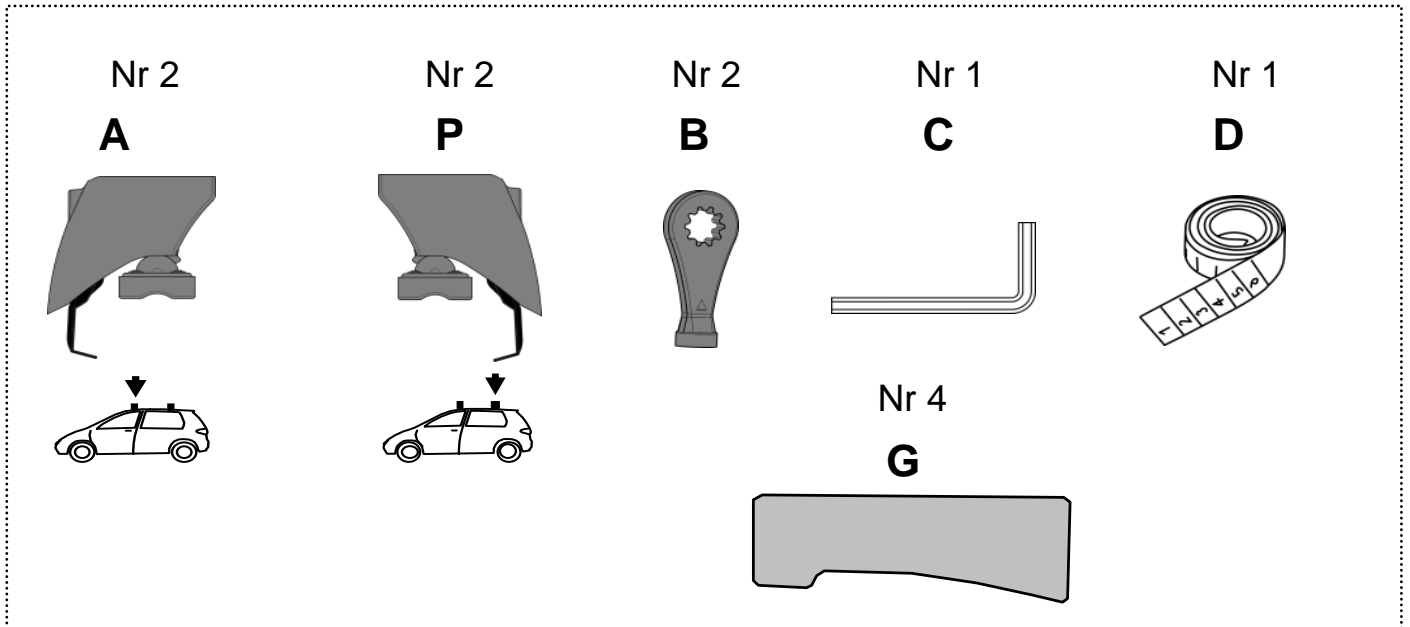

+

KIT ALU

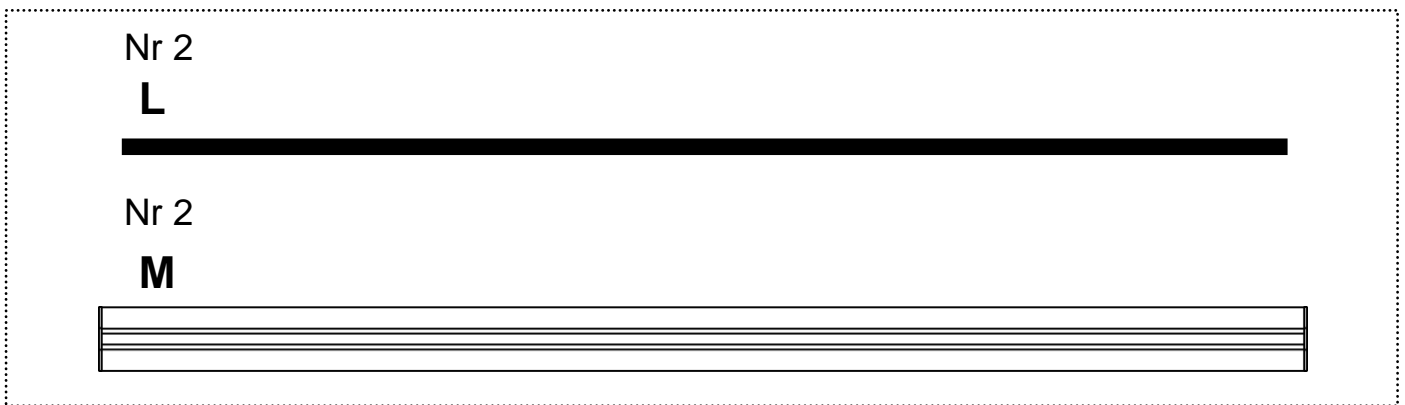

=

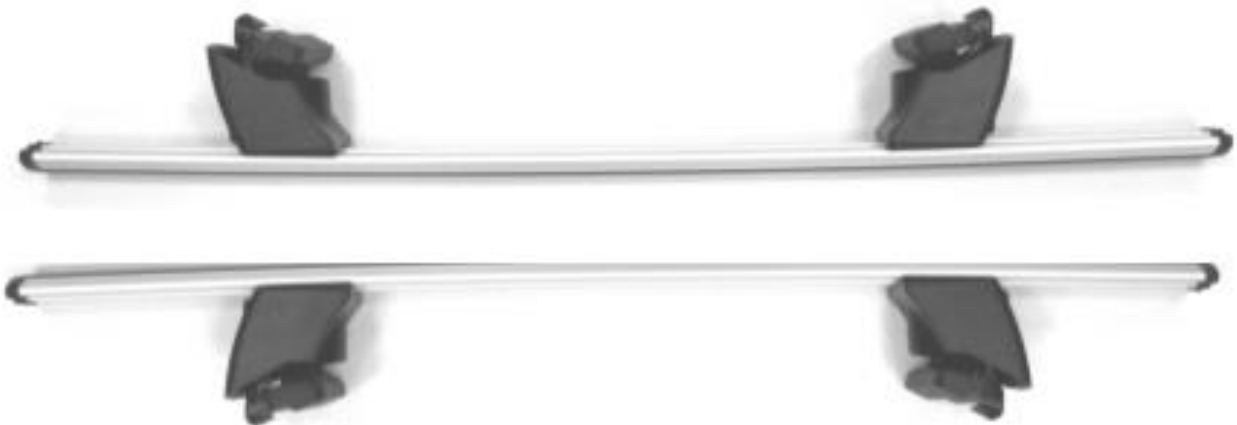

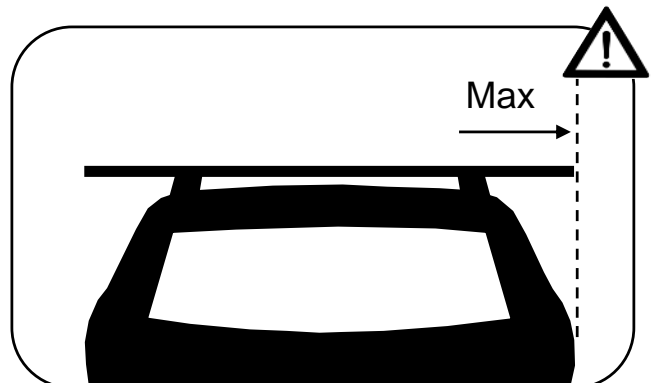
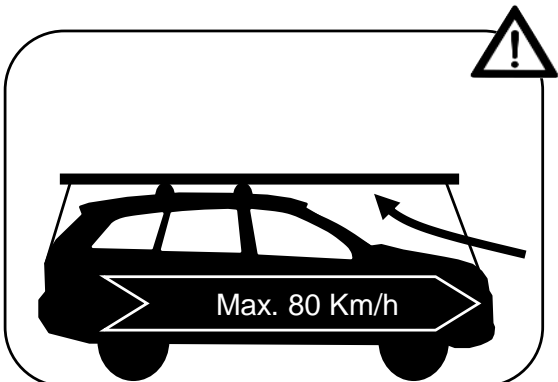
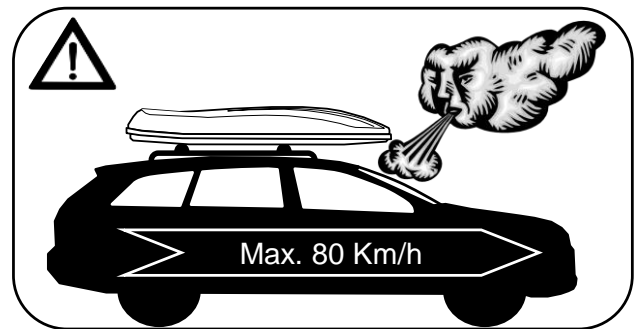
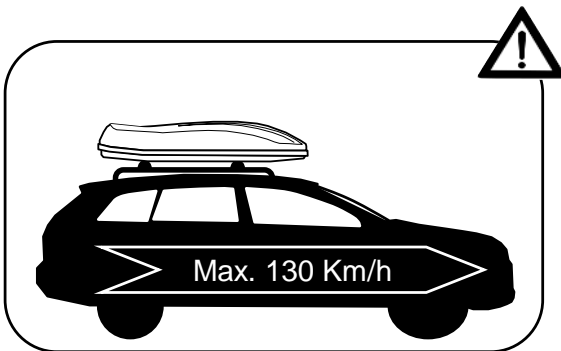
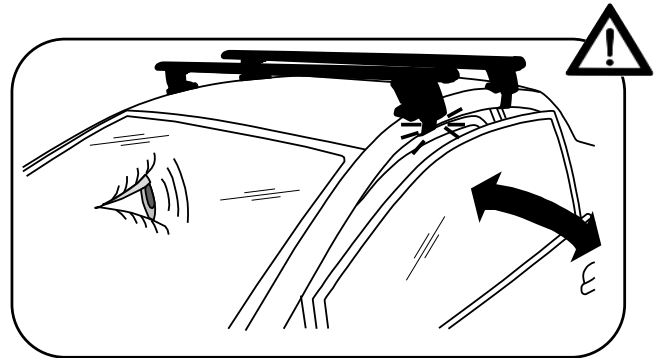
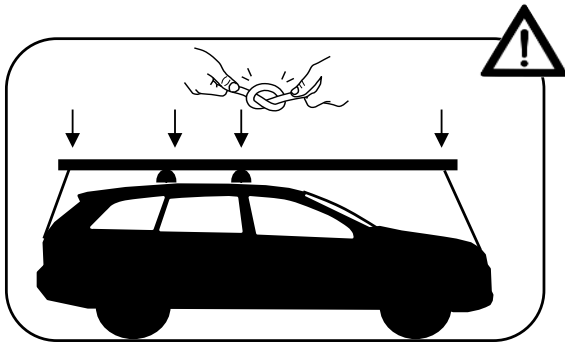
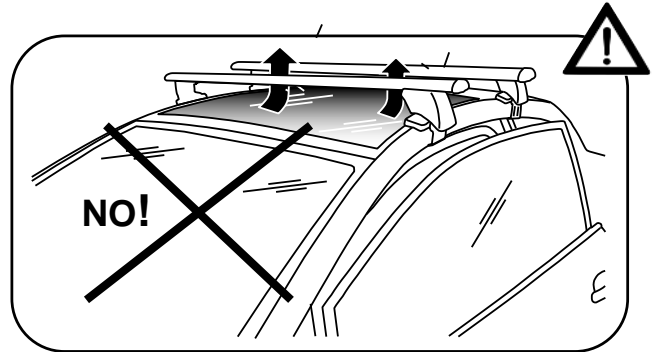
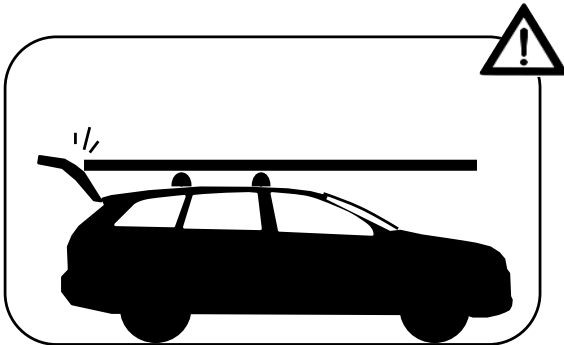
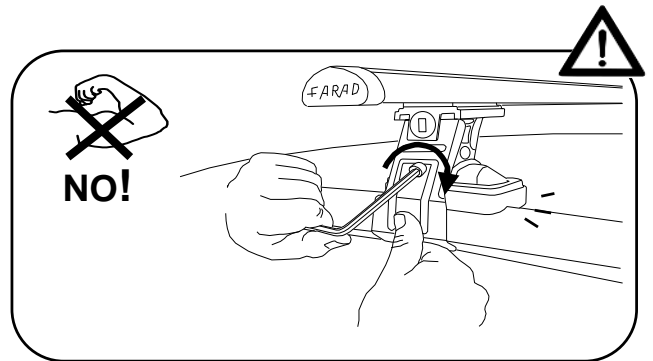
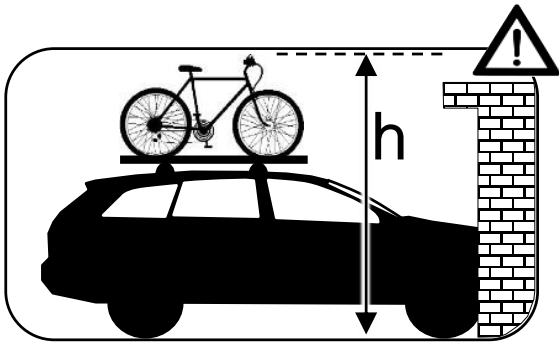

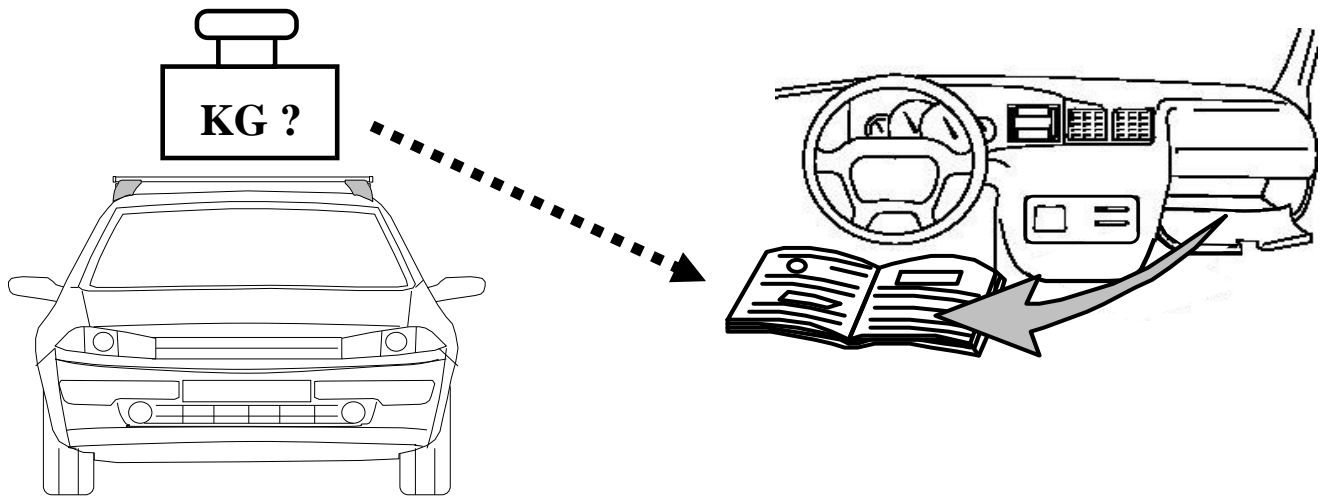

- I Controllare carico del tetto sul manuale dell'auto
- PL Sprawdź ładowność dachu w instrukcji
- GB Check roof load capacity in car instruction
- NL check de handleiding belasting van het dak van de auto
- F vérifier le chargement manuel du toit de la voiture
- D überprüfen Sie die manuelle Beladung der Autodach
- E comprobar la carga manual del techo del coche
- SWE kontrollera manuell inläggning på taket av bilen

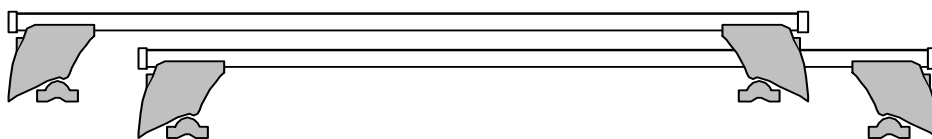
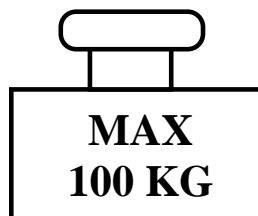
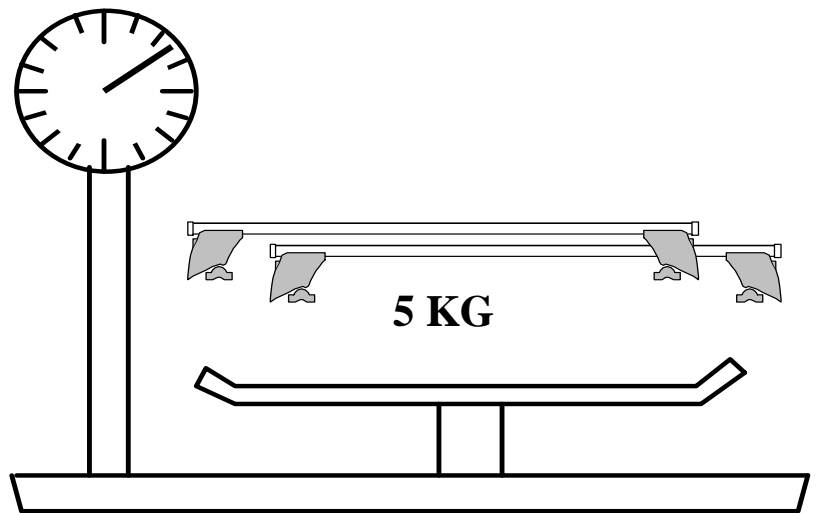

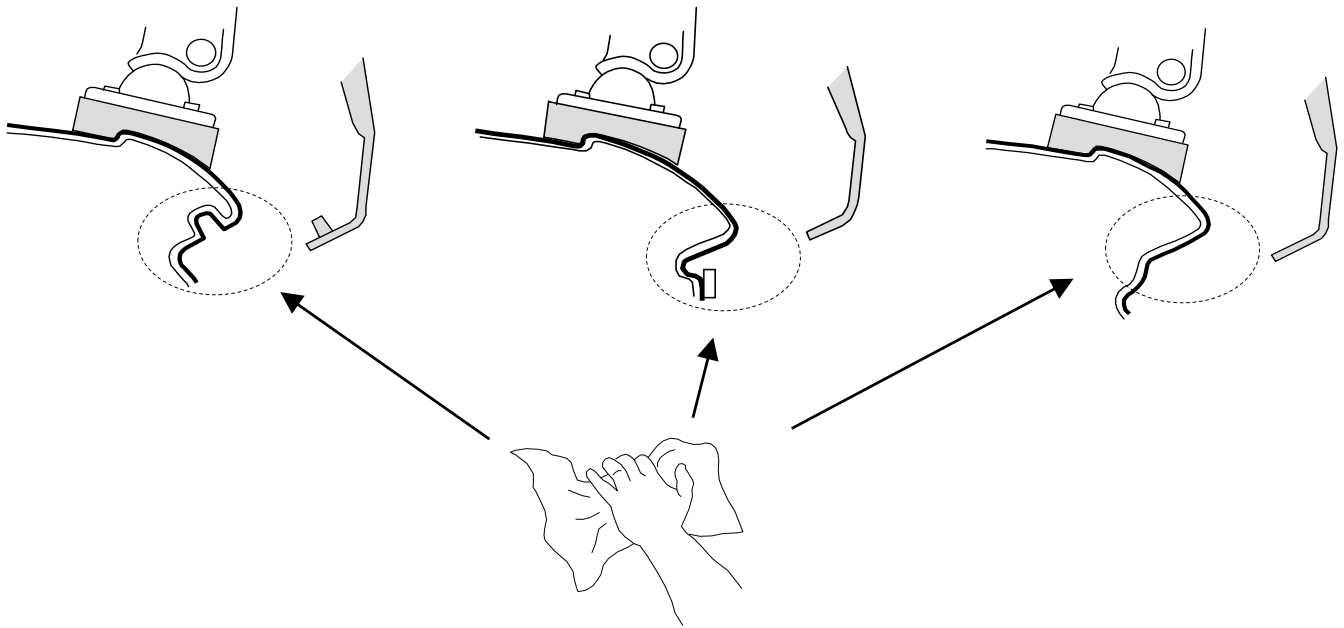
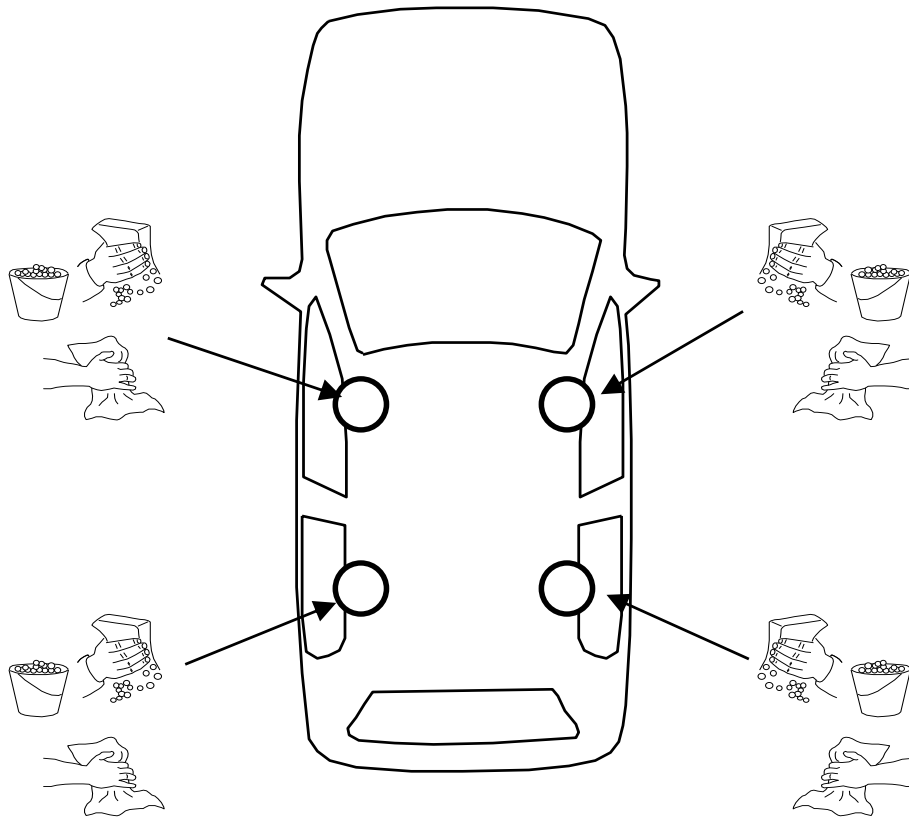

I Montaggio Barra Anteriore
PL Montaż Bagażnika Bazowego Tylnego
D Montage Vorderes Dachträgers
SWE Montering Av Främre Lasthållaren

F Fixation Barre Avant
GB Fitting Front Roof Bar
NL Montage Voorste Dakdrager
E Fijación Barra Frontal

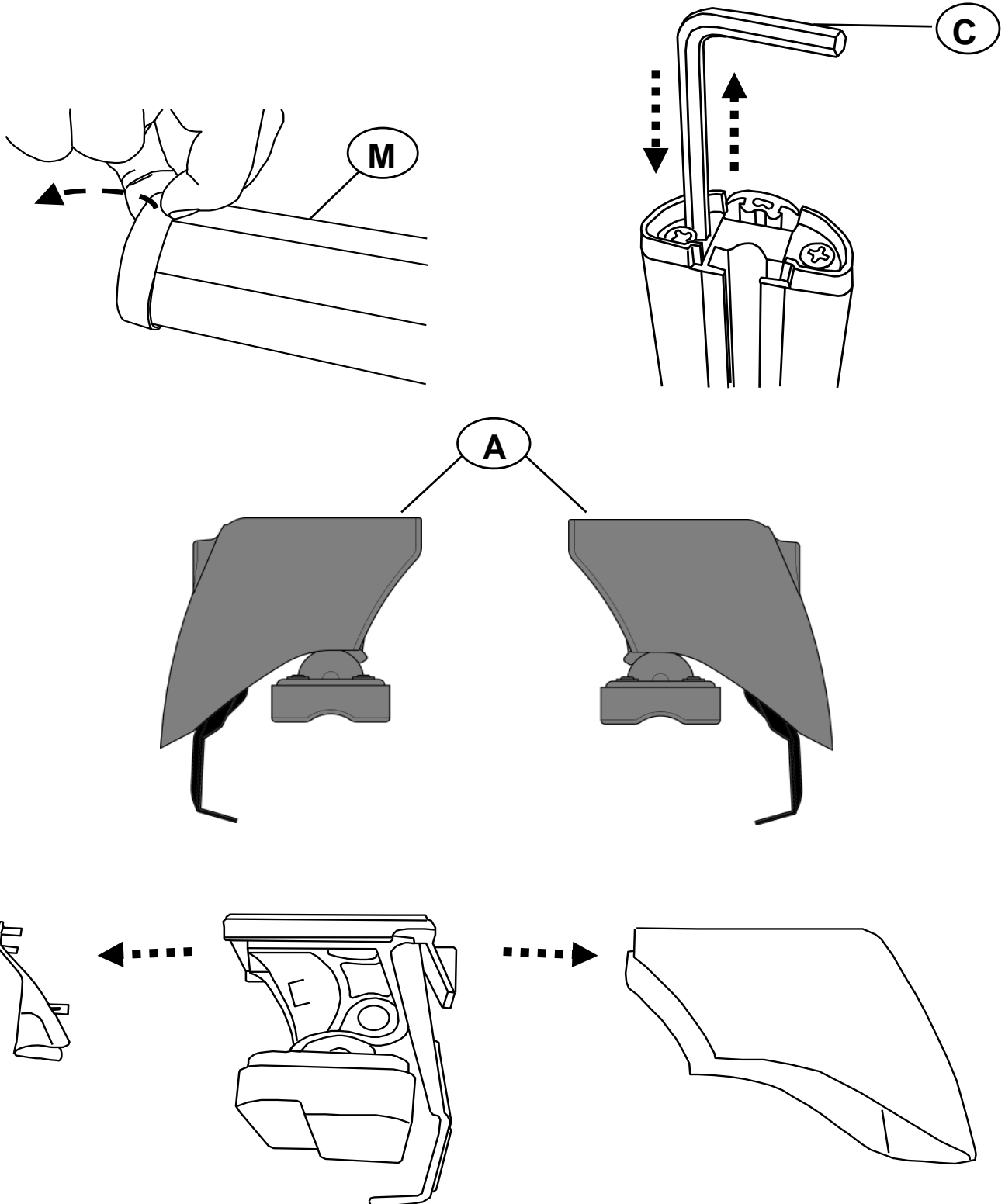



M

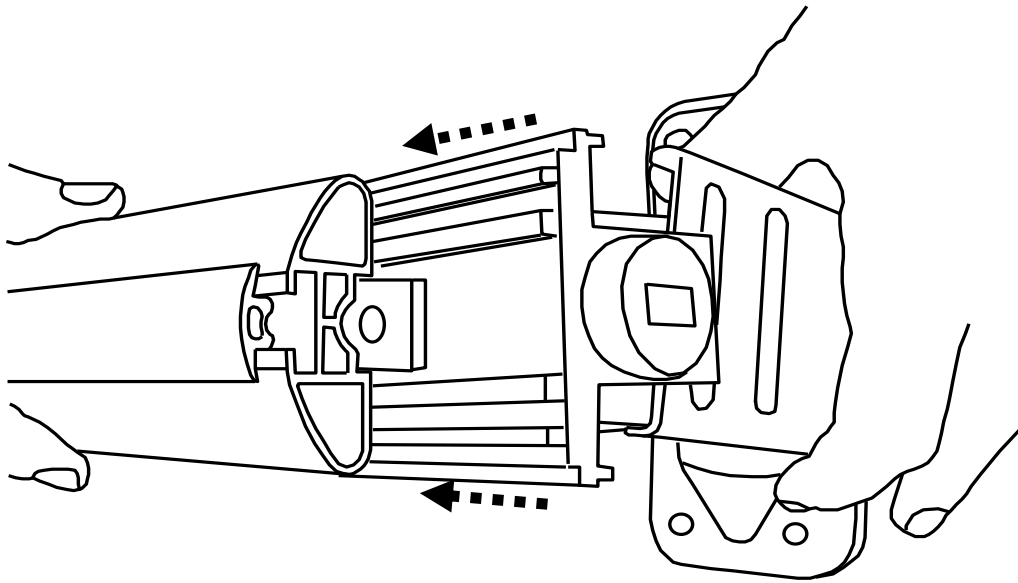
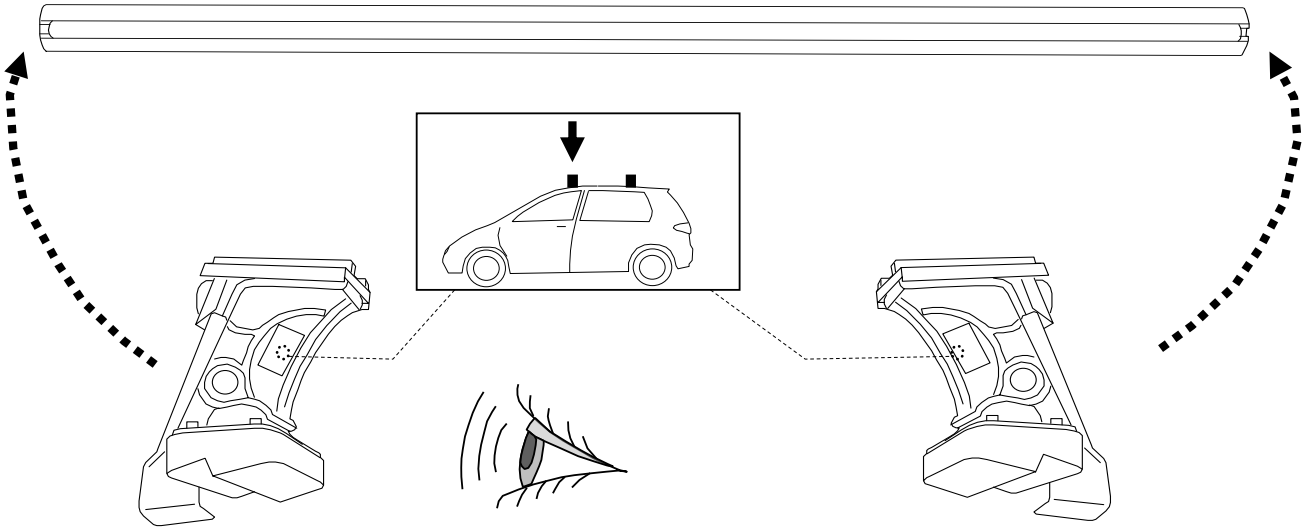

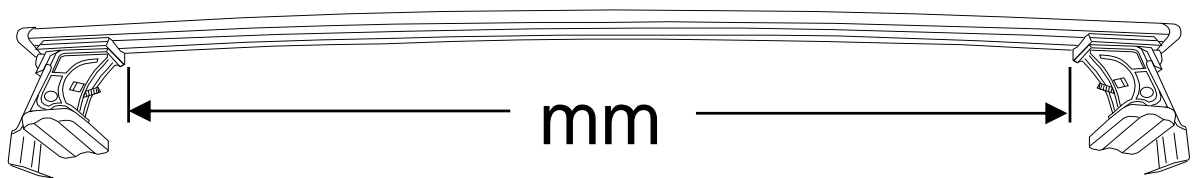

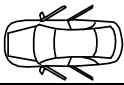
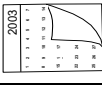

				R	mm
HYUNDAI	IX20	5	2010-2019	R= 37	1045
KIA	VENGA	5	2010-2019	R= 37	1045
TOYOTA	AURIS	5	2007-2012	R= 44	985
TOYOTA	AURIS	5	2013-2018	R= 43	980

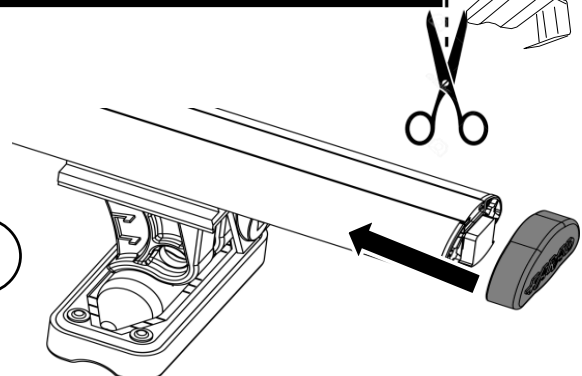
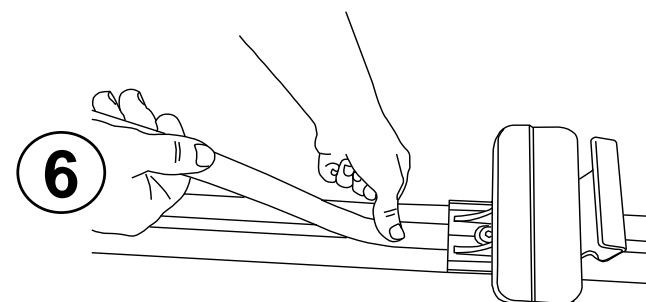
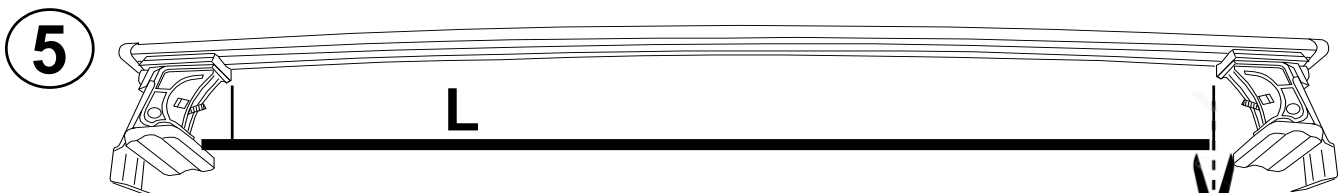
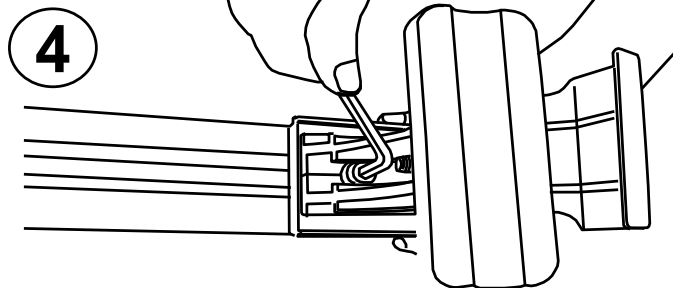
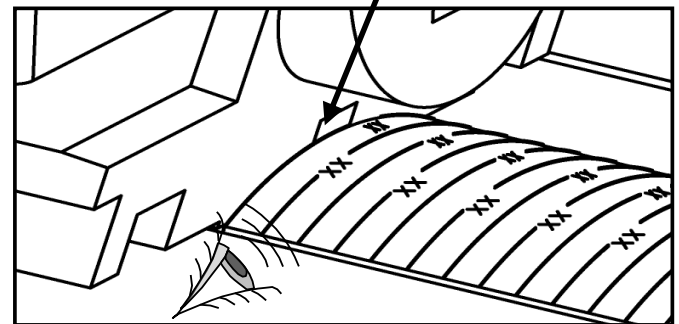
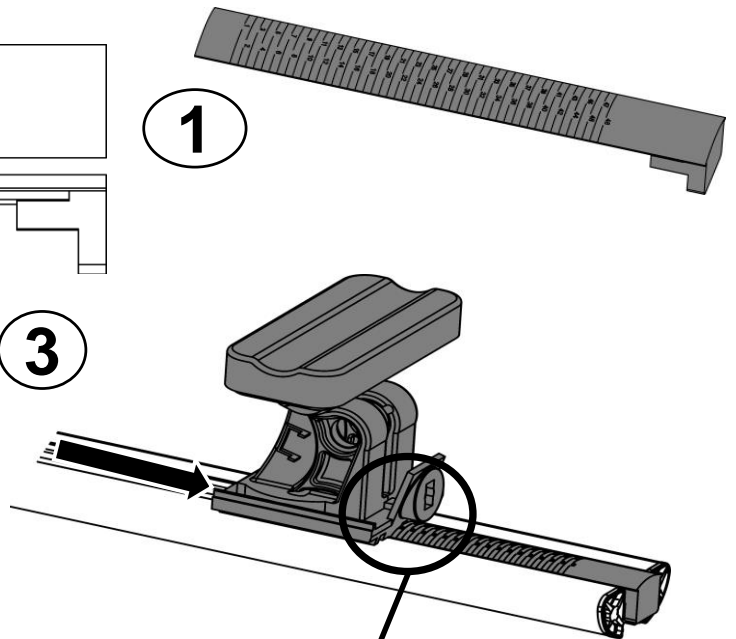
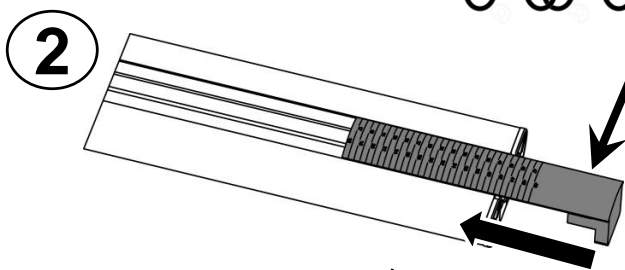
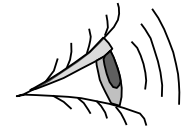
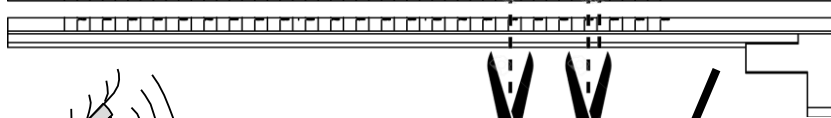
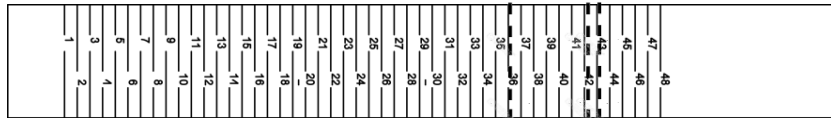
R - R

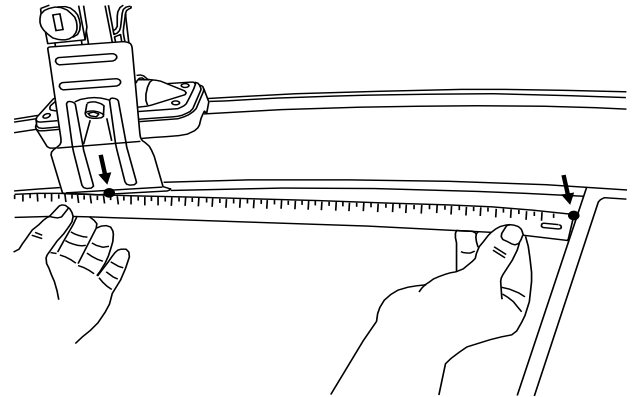
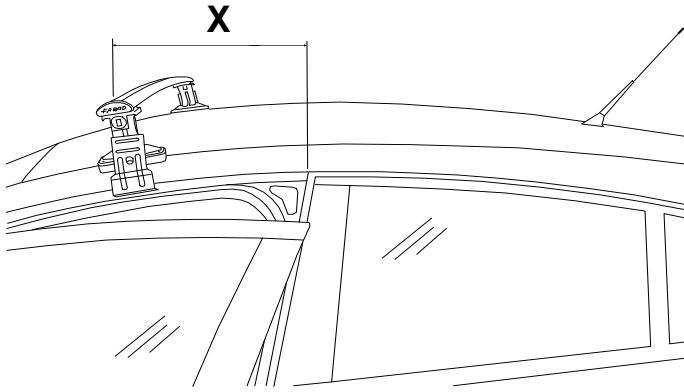
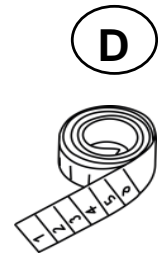
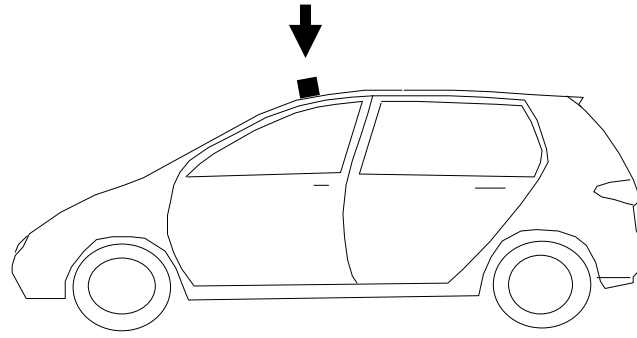

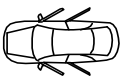
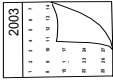

				X
HYUNDAI	IX20	5	2010-2019	X= 310
KIA	VENGA	5	2010-2019	X= 310
TOYOTA	AURIS	5	2007-2012	X= 260
TOYOTA	AURIS	5	2013-2018	X= 320

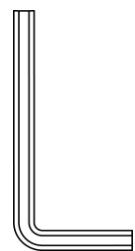
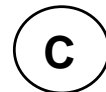
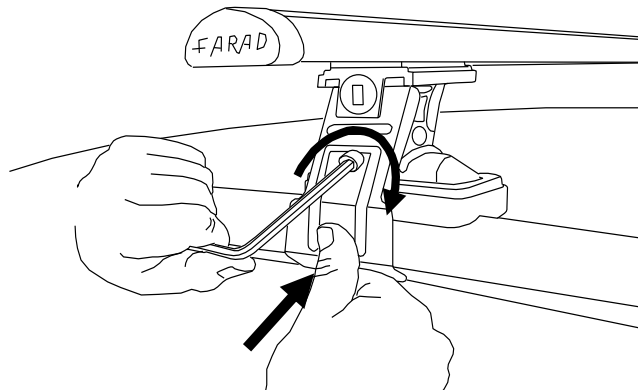
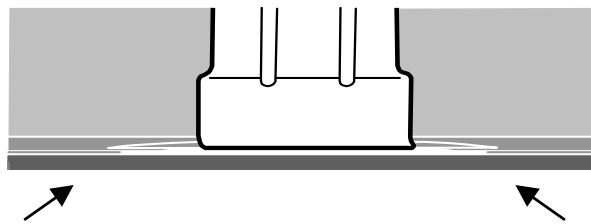
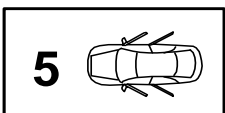

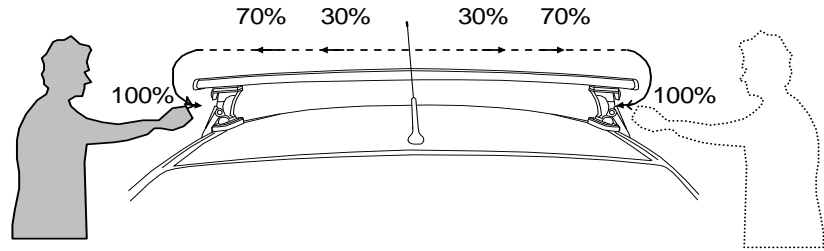

- I Alternare il fissaggio delle viti
- PL Śruby dokręcaj naprzemiennie
- GB Tighten alternately
- NL Afwisselend aan de linker- en de rechterkant aandraaien

- F Serrer alternativement chaque côté
- D Die Schrauben abwechselnd anziehen
- E Apretar alternativamente
- SWE Dra åt växelvis

HYUNDAI IX20 2010-2019 KIA VENGA 2010-2019 TOYOTA AURIS 2007-2012

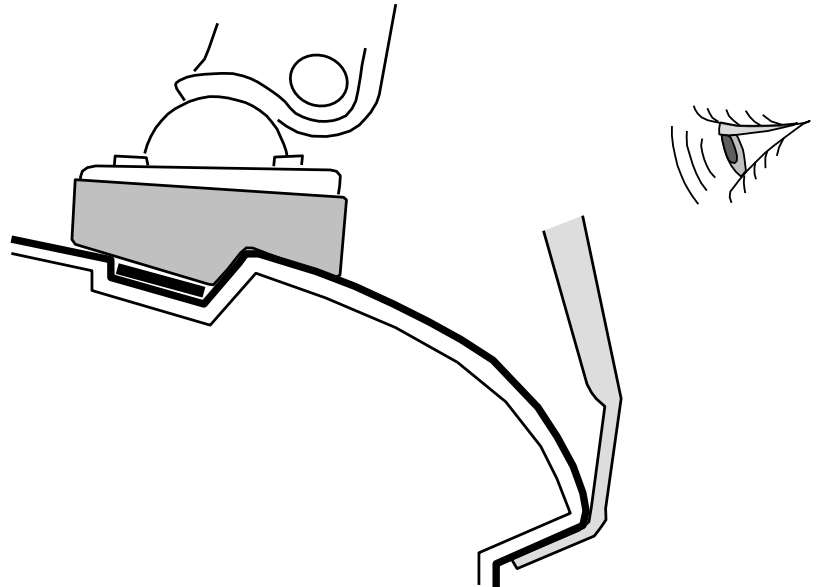

TOYOTA AURIS 2013-2018

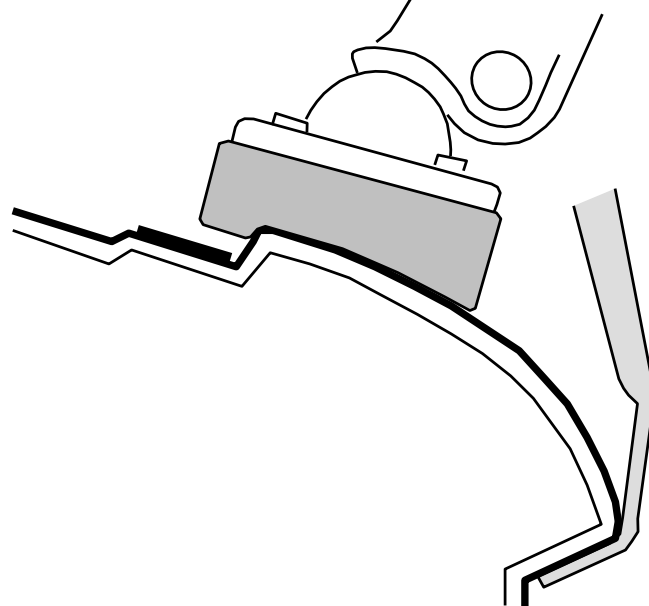
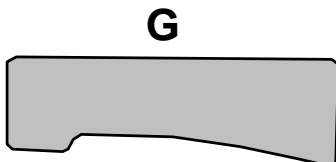

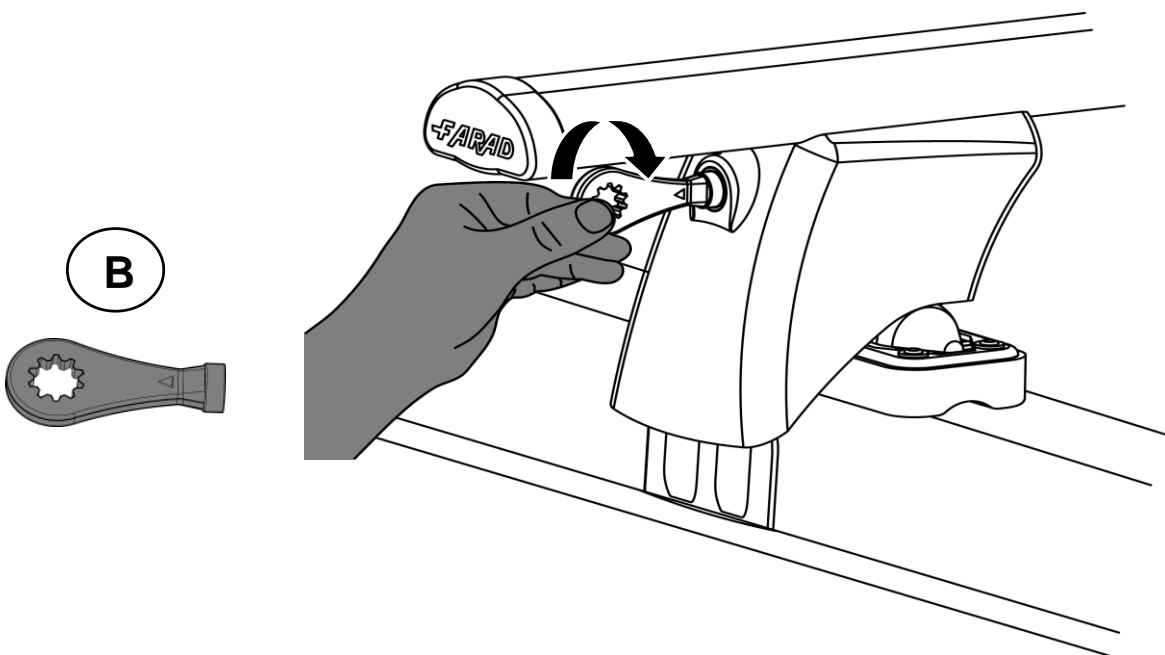
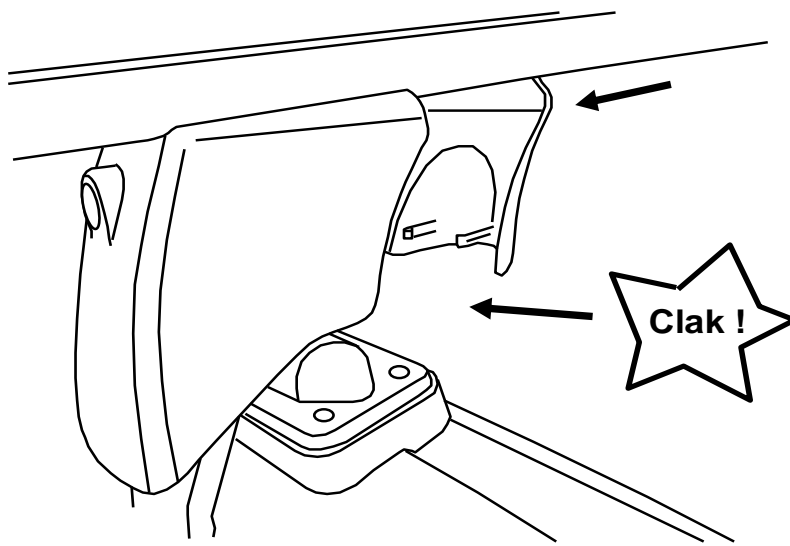
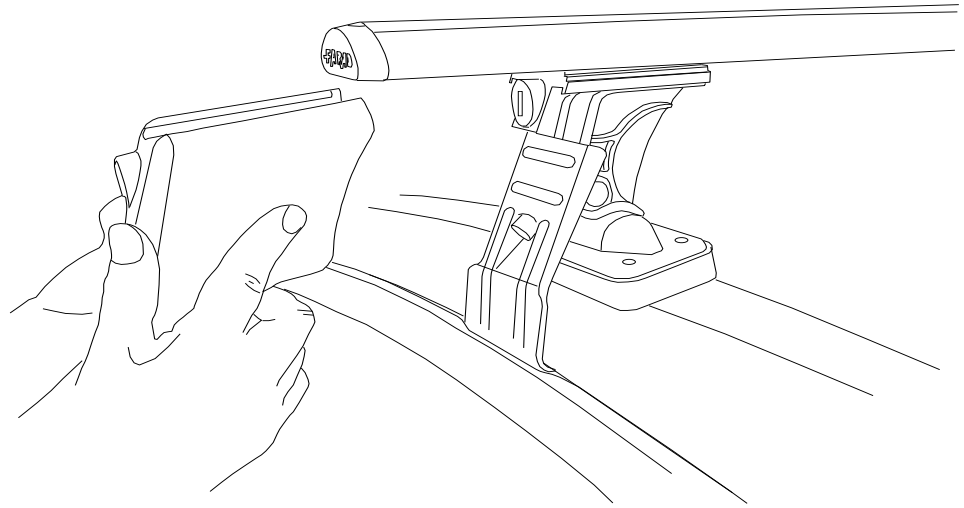

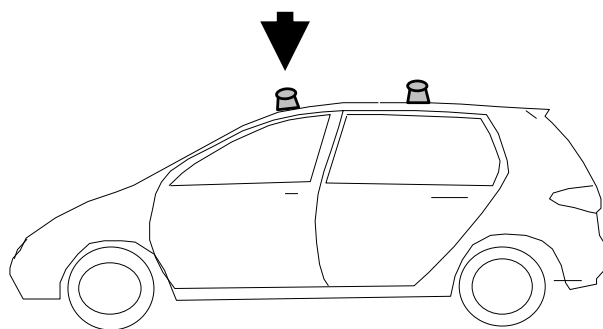

HYUNDAI IX20 2010-2019 KIA VENGA 2010-2019 TOYOTA AURIS 2007-2012



TOYOTA AURIS 2013-2018



- I** CONTROLLARE PERIODICAMENTE IL FISSAGGIO DELLE VITI
- PL** OKRESOWO SPRAWDZAJ MOCOWANIE ŚRUB
- GB** CHECK THE SCREW FASTENING PERIODICALLY
- D** REGELMÄSSIG ÜBERPRÜFEN DIE BEFESTIGUNG DER SCHRAUBEN
- SWE** REGELBUNDET KONTROLLERA OM FASTSTÄLLANDE AV SKRUVARNA
- F** VERIFIEZ LA FIXATION DES VIS PERIODIQUEMENT

I **Montaggio barra posteriore**

PL **Montaż Bagażnika Bazowego Przedniego**

SWE **Montering Främre Lasthållaren**

NL **Montage Achterste Dakdrager**

F **Fixation Barre Arriere**

GB **Fitting Rear Roof Bar**

E **Fijación Barra Trasera**

D **Montage Heckdachträgers**

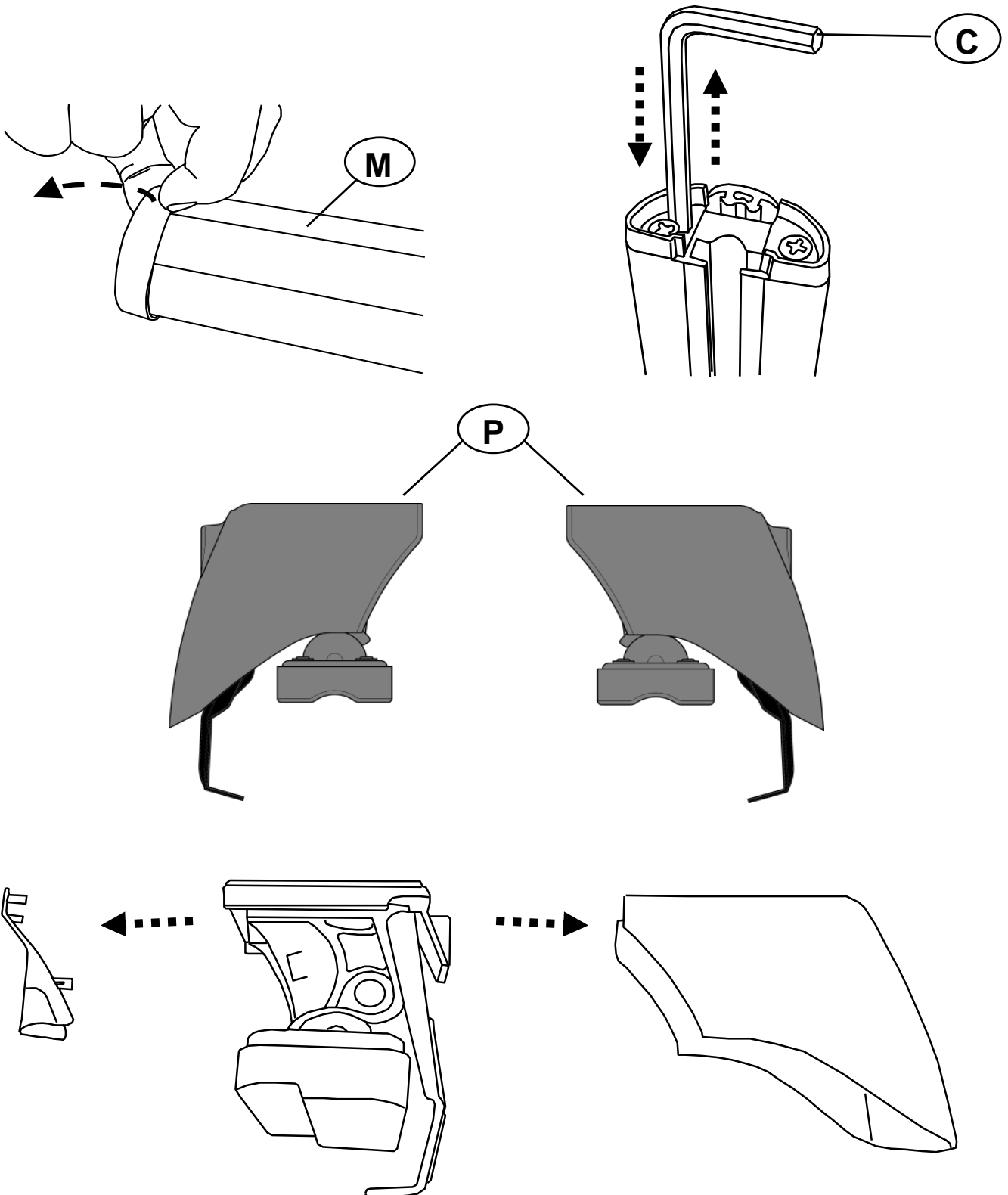



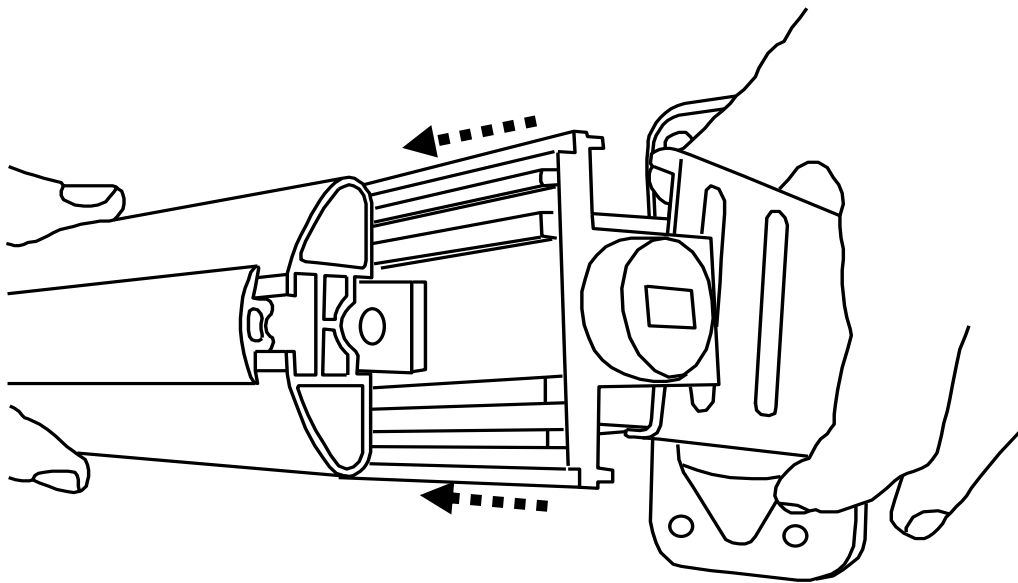
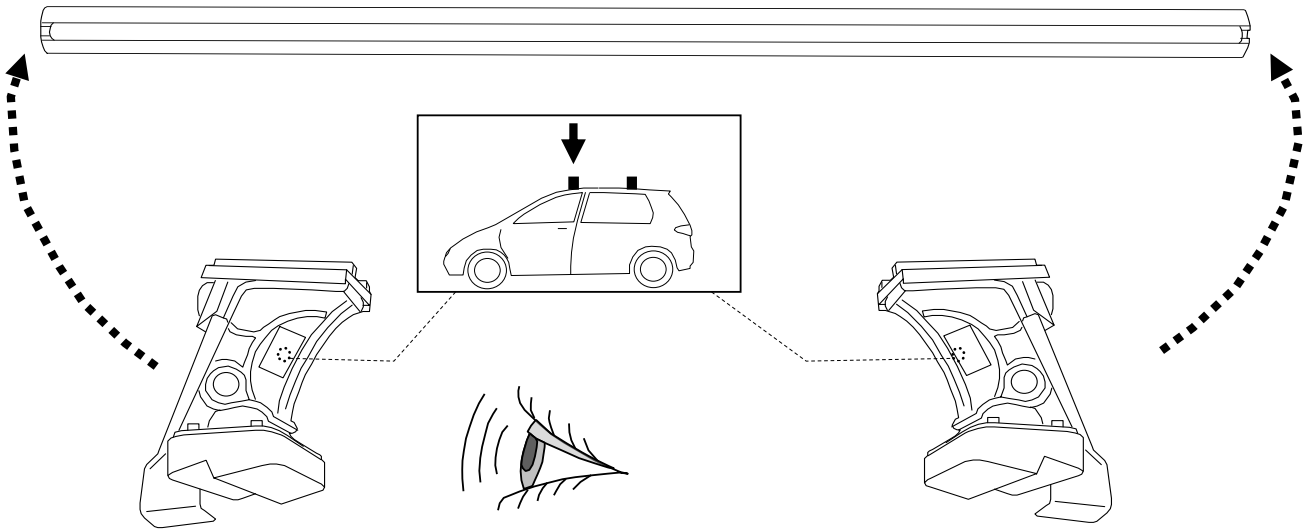

M

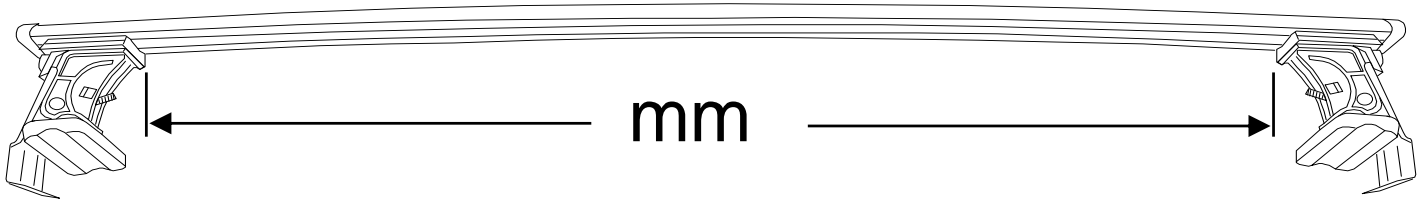



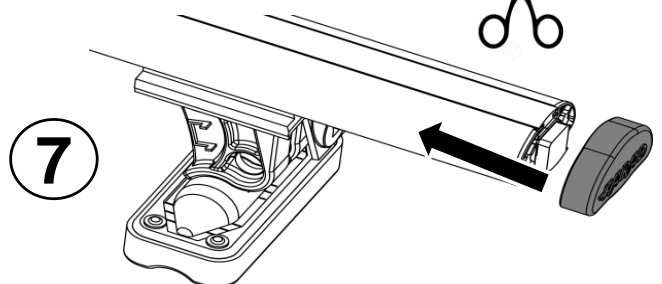
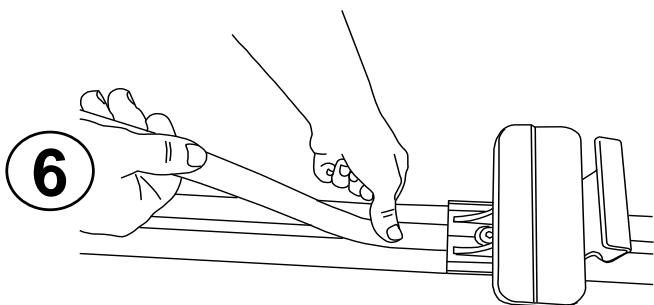
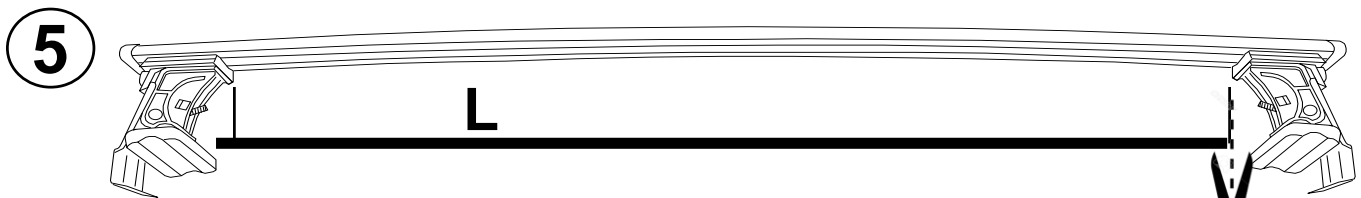
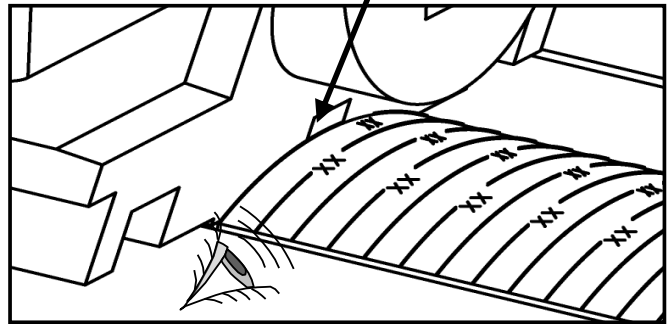
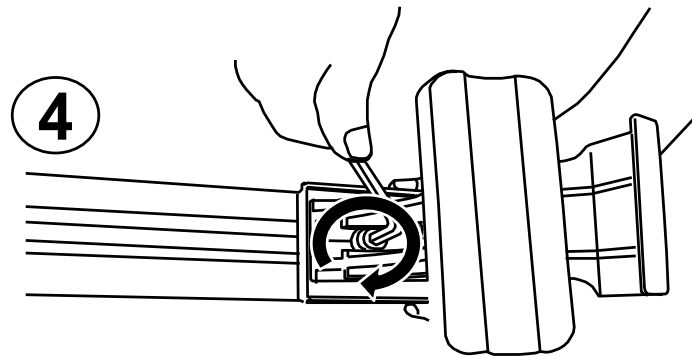
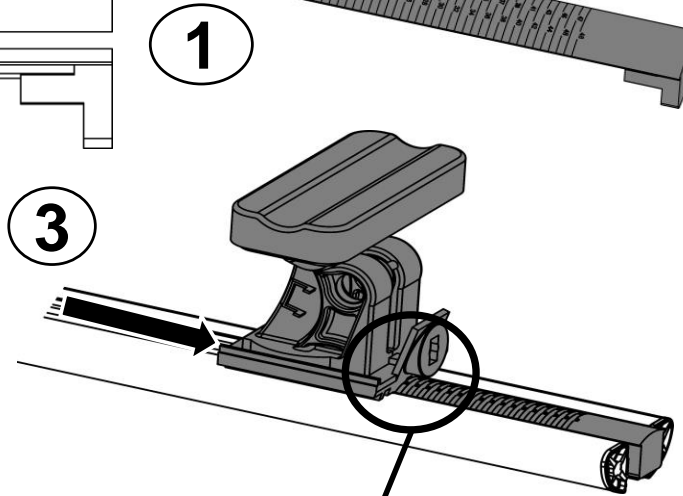
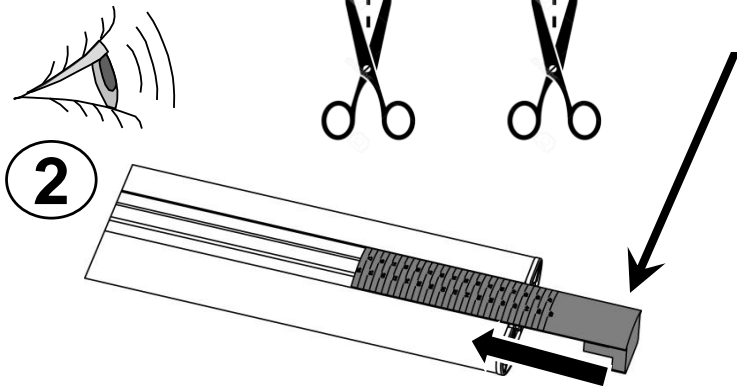
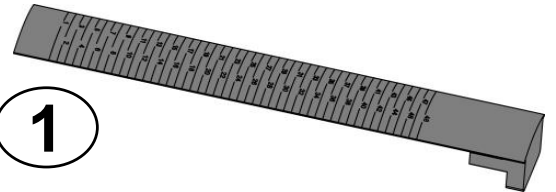
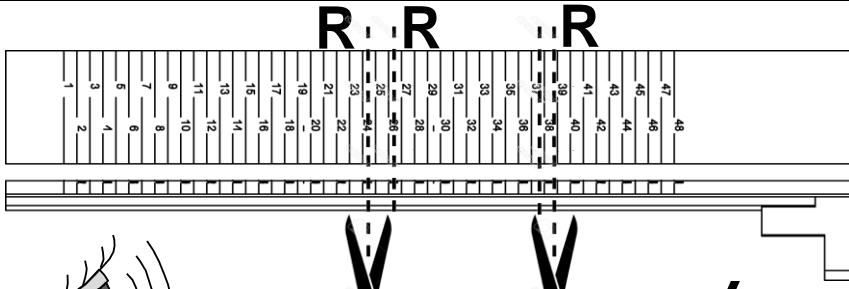

				R	mm
HYUNDAI	IX20	5	2010-2019	R= 27	995
KIA	VENGA	5	2010-2019	R= 25	985
TOYOTA	AURIS	5	2007-2012	R= 39	960
TOYOTA	AURIS	5	2013-2018	R= 37	950

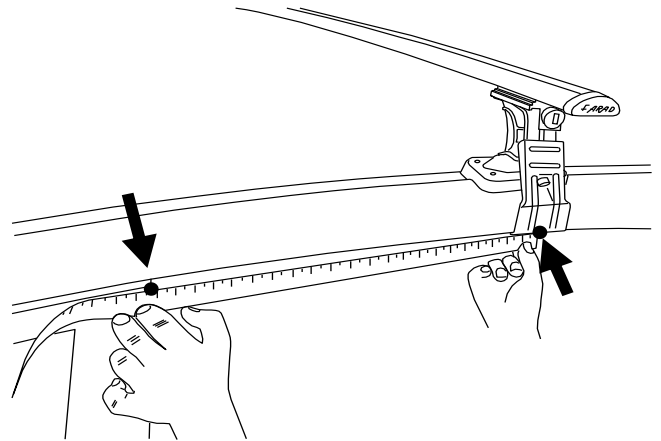
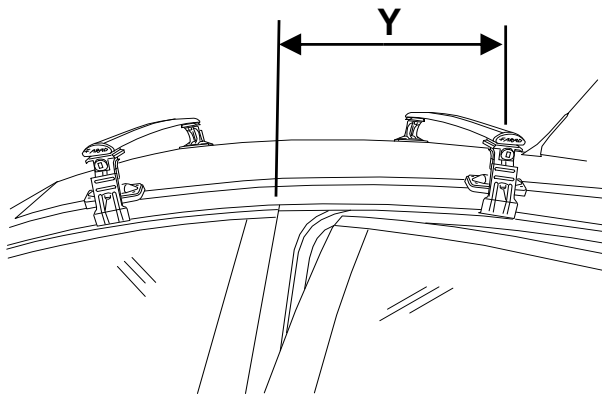
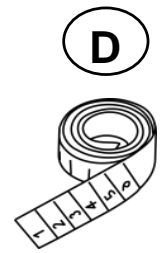
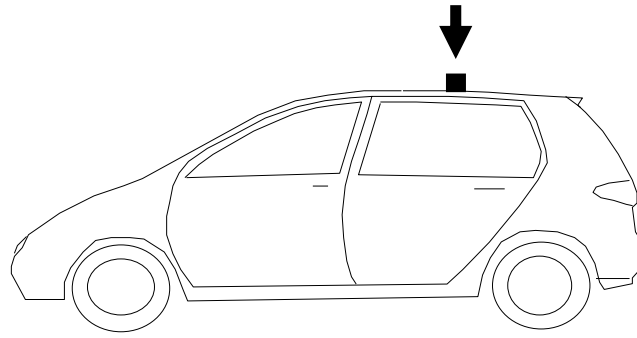



				Y
HYUNDAI	IX20	5	2010-2019	Y= 290
KIA	VENGA	5	2010-2019	Y= 290
TOYOTA	AURIS	5	2007-2012	Y= 440
TOYOTA	AURIS	5	2013-2018	Y= 430

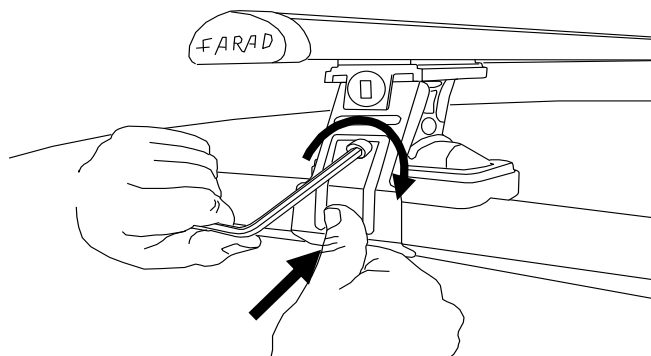
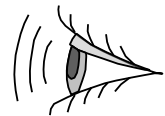
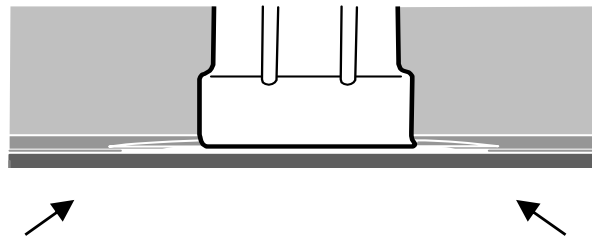
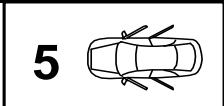

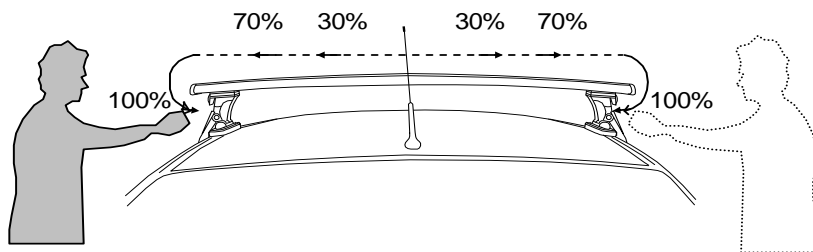

- | | | | |
|----|---|-----|------------------------------------|
| I | Alternare il fissaggio delle viti | F | Serrer alternativement chaque côté |
| PL | Śruby dokręcaj naprzemiennie | D | Die Schrauben abwechselnd anziehen |
| GB | Tighten alternately | E | Apretar alternativamente |
| NL | Afwisselend aan de linker- en de rechterkant aandraaien | SWE | Dra åt växelvis |

HYUNDAI IX20 2010-2019 KIA VENGU 2010-2019 TOYOTA AURIS 2007-2012

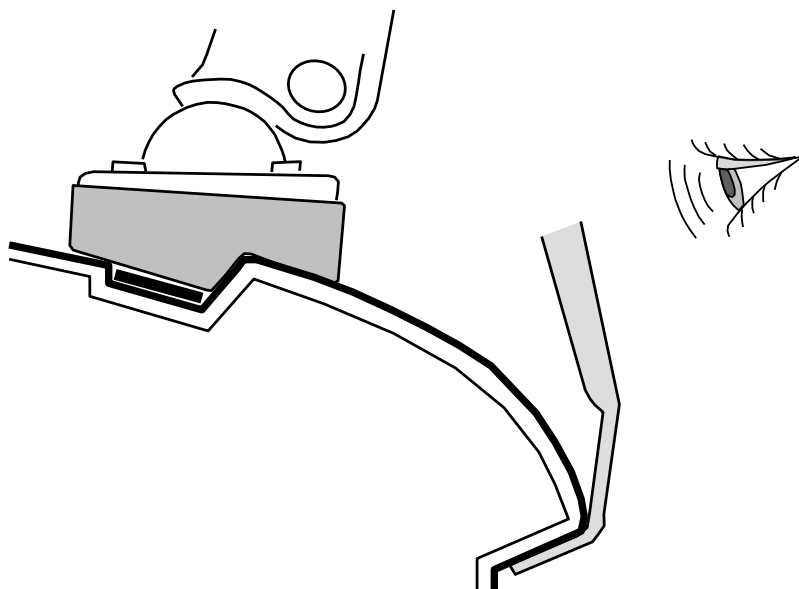

TOYOTA AURIS 2013-2018



G

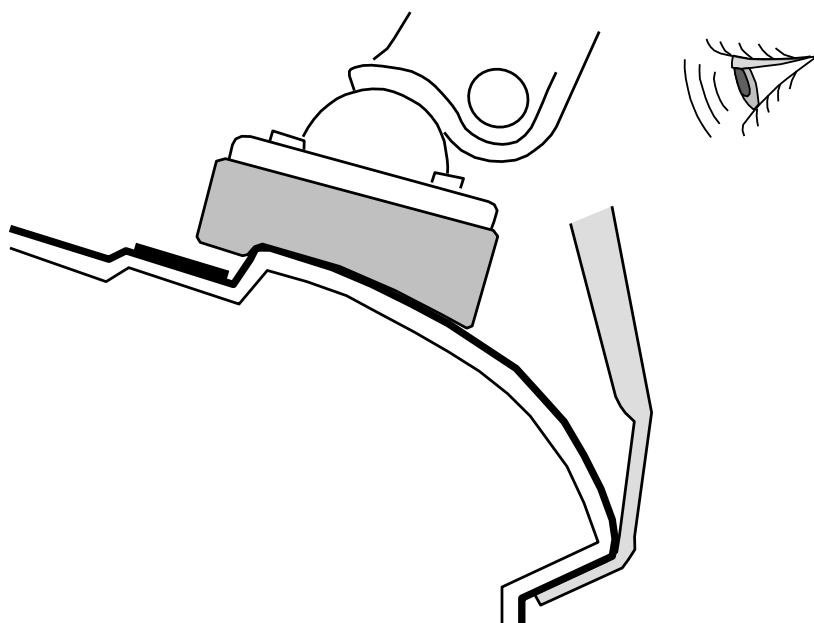
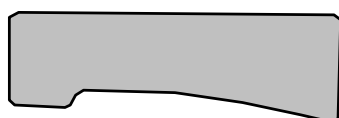

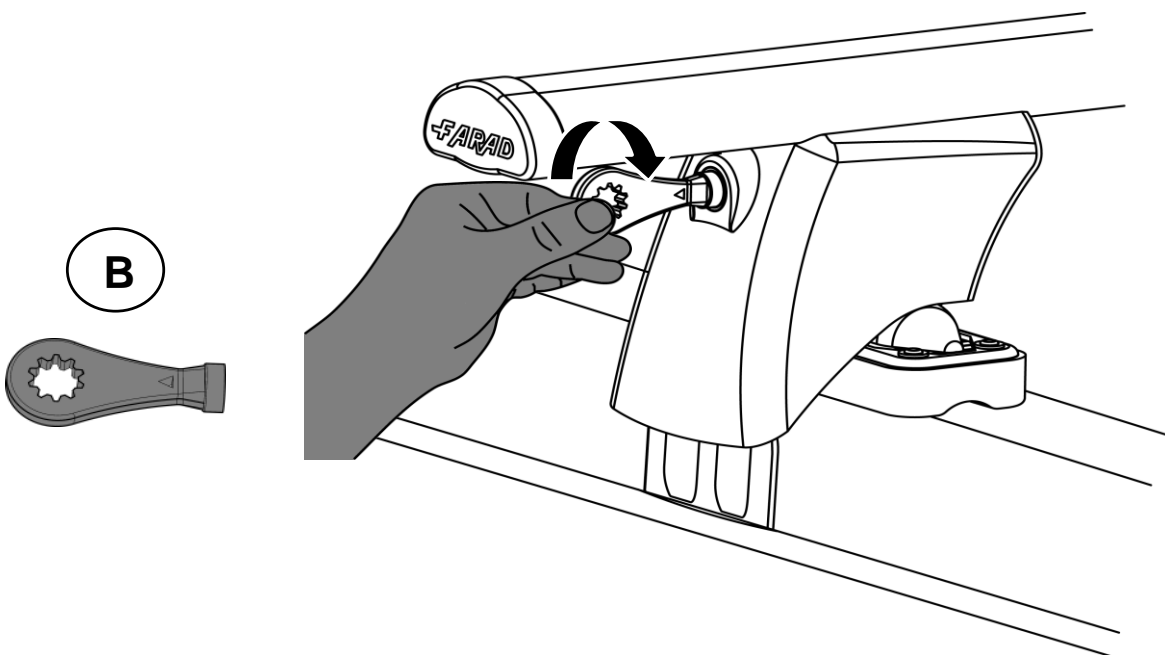
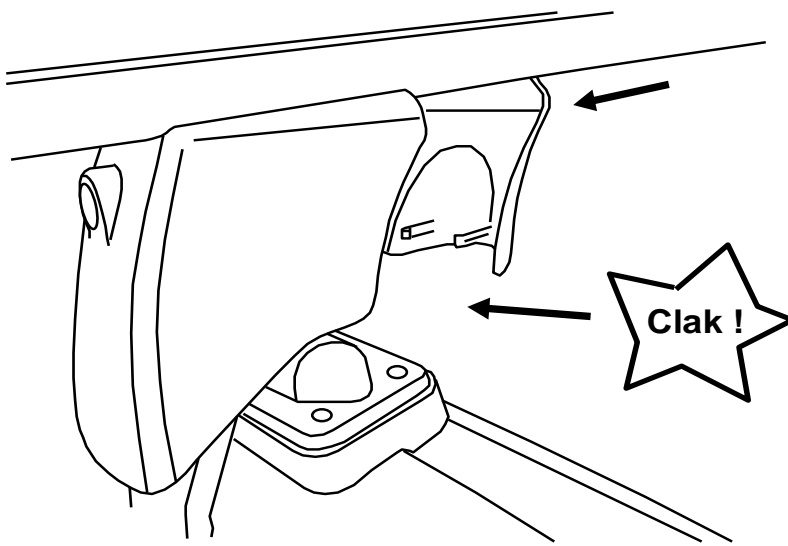
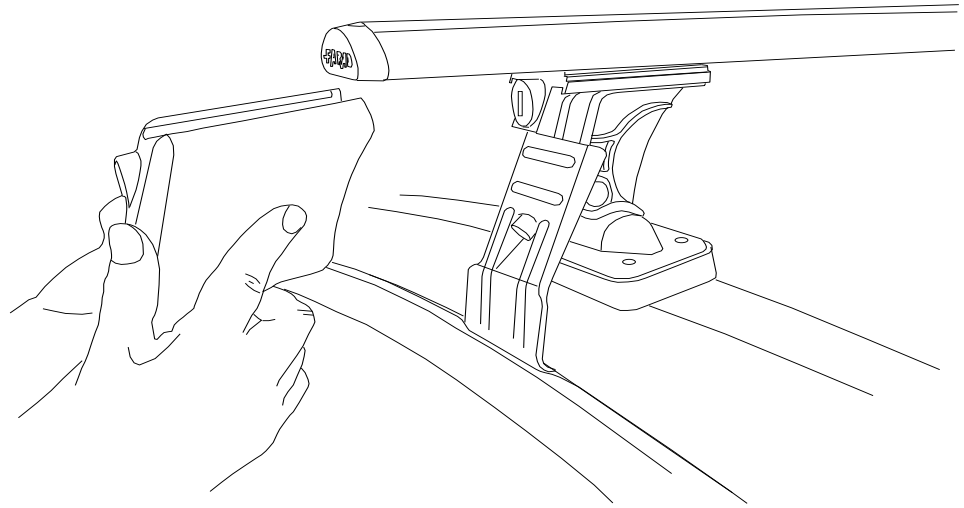

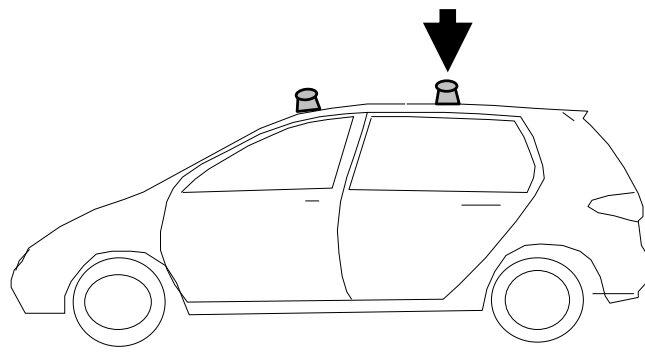

HYUNDAI IX20 2010-2019 KIA VENGU 2010-2019 TOYOTA AURIS 2007-2012



TOYOTA AURIS 2013-2018



- I** CONTROLLARE PERIODICAMENTE IL FISSAGGIO DELLE VITI
- PL** OKRESOWO SPRAWDZAJ MOCOWANIE ŚRUB
- GB** CHECK THE SCREW FASTENING PERIODICALLY
- D** REGELMÄSSIG ÜBERPRÜFEN DIE BEFESTIGUNG DER SCHRAUBEN
- SWE** REGELBUNDET KONTROLLERA OM FASTSTÄLLANDE AV SKRUVARNA
- F** VERIFIEZ LA FIXATION DES VIS PERIODIQUEMENT

RICAMBI - SPARE PARTS



PIEDE GIREVOLE
90341 / 2

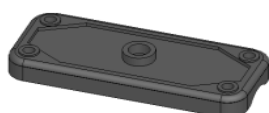

PIEDE FISSO
90341 / 15

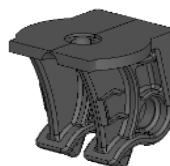

SUPPORTO CENTRALE
90341 / 1

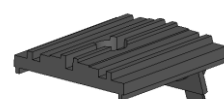

SUPPORTO BARRA
90341 / 5



SOTTO PIEDE SP01
90341 / 3



SOTTO PIEDE SP03
90341 / 16



SOTTO PIEDE SP04
90341 / 13

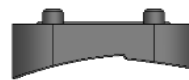

SOTTO PIEDE SP07
90341 / 11

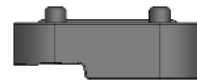

SOTTO PIEDE SP08
90341/14



SOTTO PIEDE SP10
90341 / 12



SOTTO PIEDE SP12
90341 / 1



CHIAVE ESAGONALE 6
9331 / 148

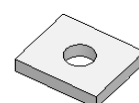

PIASTRINA
90341 / 21



DISTANZIALE
90341 / 20



NOTTOLINO + N° COMB.
90341 / 6



SOTTOTAPPO
90241 / 9



TAPPO BARRA
90241 / 6

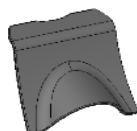

INVOLUCRO POST.
90341 / 9

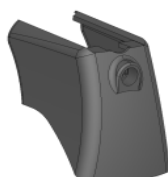

INVOLUCRO ANTERIORE
90341 / 8



CHIAVE + N° COMB
90341 / 7

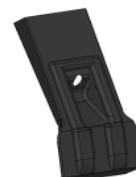

PALETTA
90341 / 4



BARRA ALLUMINIO
90241 / 7

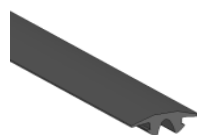

GUARNIZIONE BARRA
90241 / 8



RIGA CARTA
90341 / 19



PERNO
90241 / 15

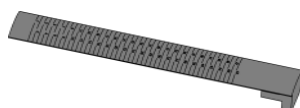

GUARNIZIONE
NUMERICA
91141 / 14

FARAD[®]
made in italy

www.faradworld.com

